



EN

Mobile Multimedia Station

IVA-D900

FR

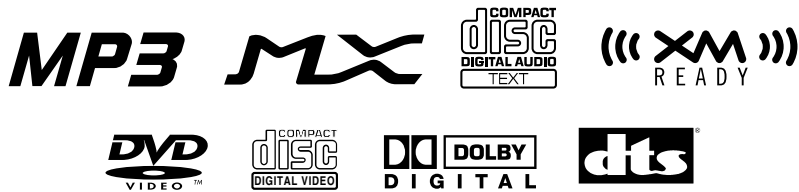

ES

- **OWNER'S MANUAL**
Please read before using this equipment.
- **MODE D'EMPLOI**
Veuillez lire avant d'utiliser cet appareil.
- **MANUAL DE OPERACIÓN**
Léalo antes de utilizar este equipo.

ALPINE ELECTRONICS MARKETING, INC.
1-1-8 Nishi Gotanda,
Shinagawa-ku,
Tokyo 141-0031, Japan
Phone 03-5496-8231

ALPINE ELECTRONICS OF AMERICA, INC.
19145 Gramercy Place, Torrance,
California 90501, U.S.A.
Phone 1-800-ALPINE-1 (1-800-257-4631)

ALPINE ELECTRONICS OF CANADA, INC.
7300 Warden Ave., Suite 203, Markham,
Ontario L3R 9Z6, Canada
Phone 1-800-ALPINE-1 (1-800-257-4631)

ALPINE ELECTRONICS OF AUSTRALIA PTY. LTD.
6-8 Fiveways Boulevard Keysborough,
Victoria 3173, Australia
Phone 03-9769-0000

ALPINE ELECTRONICS GmbH
Kreuzerkamp 7,
40878 Ratingen, Germany
Phone 02102-4550

ALPINE ELECTRONICS OF U.K. LTD.
Alpine House
Fletchamstead Highway, Coventry CV4 9TW, U.K.
Phone 0870-33 33 763

ALPINE ELECTRONICS FRANCE S.A.R.L.
(RCS PONTOISE B 338 101 280)
98, Rue de la Belle Etoile, Z.I. Paris Nord II,
B.P. 50016, 95945 Roissy Charles de Gaulle
Cedex, France
Phone 01-48638989

ALPINE ITALIA S.p.A.
Viale C. Colombo 8, 20090 Trezzano
Sul Naviglio (MI), Italy
Phone 02-484781

ALPINE ELECTRONICS DE ESPAÑA, S.A.
Portal de Gamarra 36, Pabellón, 32
01013 Vitoria (Alava)-APDO 133, Spain
Phone 945-283588

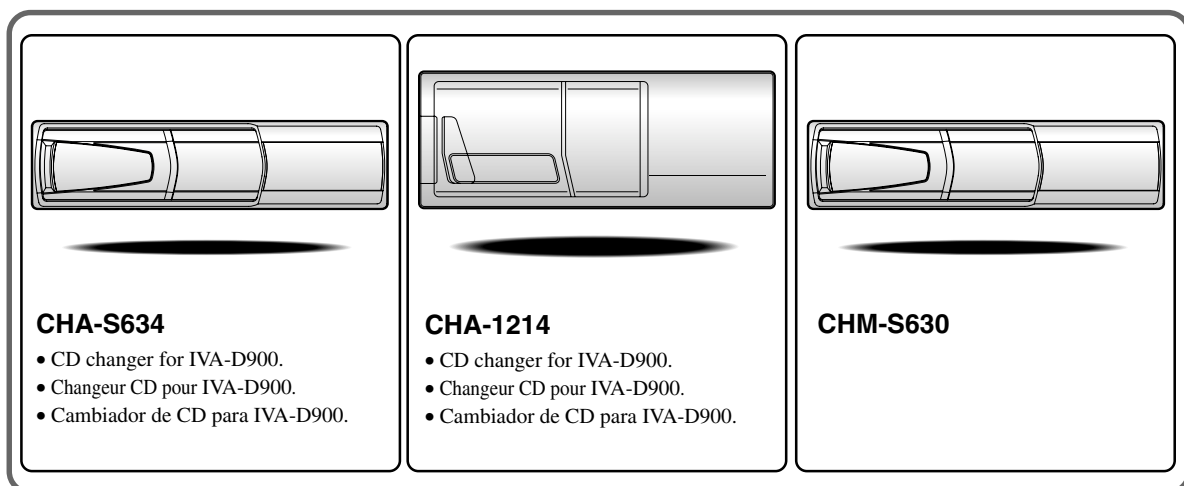

Alpine CD Changers Give You More!

More musical selections, more versatility, more convenience.

The CHA-S634 is a high-performance 6-disc changer with a new M DAC, CD-R/RW PLAY BACK, MP3 PLAY BACK and CD TEXT. The CHA-1214 Ai-NET model holds 12 discs, and the CHM-S630 M-Bus model is a super-compact 6-disc changer with a CD-R/RW PLAY BACK.

Changeurs de CD Alpine : vous avez le choix!

Plus de sélections musicales, plus de souplesse, plus de confort.

Le modèle CHA-S634 est un changeur 6 disques ultra performant équipé des nouvelles fonctions M DAC, CD-R/RW PLAY BACK, MP3 PLAY BACK et CD TEXT. Le modèle CHA-1214 Ai-NET contient 12 disques. Le modèle CHM-S630 M-Bus est un changeur 6 disques super compact doté de la fonction CD-R/RW PLAY BACK.

¡Los cambiadores Alpine de CD le ofrecen más!

Más selecciones musicales, más versatilidad y más ventajas.

CHA-S634 es un cambiador de seis discos de alto rendimiento con nuevo M DAC, CD-R/RW PLAY BACK, MP3 PLAY BACK y CD TEXT. El modelo CHA-1214 Ai-NET alberga 12 discos y el modelo CHM-S630 M-Bus es un cambiador de seis discos de tamaño reducido con un CD-R/RW PLAY BACK.

Contents

Operating Instructions



WARNING

| | |
|--|----------|
| WARNING | 4 |
| CAUTION | 4 |
| PRECAUTIONS | 5 |
| Discs playable on this unit | 6 |

Getting Started

| | |
|---|----|
| Basic Operation | 8 |
| Turning Power On or Off | 9 |
| Detaching and Attaching the Front Panel | 9 |
| Initial System Start-Up | 9 |
| Raising/Lowering the Monitor | 9 |
| Selecting the Monitor Opening Angle | 10 |
| Adjusting the Monitor Viewing Angle | 10 |
| Moving the monitor to be Flat | 10 |
| Adjusting the Volume/Balance (Between Left and Right)/Fader (Between Front and Rear)/Defeat | 10 |
| Lowering Volume Quickly | 10 |

Radio

| | |
|---|----|
| Listening to the Radio | 11 |
| Manual Storing of Station Presets | 11 |
| Automatic Memory of Station Presets | 11 |
| Tuning to Preset Stations | 11 |

CD/MP3

| | |
|--|----|
| Playback | 12 |
| Repeat Play | 12 |
| M.I.X. (Random Play) | 13 |
| Selecting Folders (concerning MP3) | 13 |
| About MP3 | 13 |

DVD/Video CD

| | |
|--------------------------------------|----|
| Playing DVD/Video CD | 14 |
| To display the DVD mode screen | 15 |
| If a menu screen appears | 16 |

| | |
|---|----|
| Stopping Playback (PRE STOP) | 16 |
| Stopping Playback | 16 |
| Fast-forwarding/Fast-reversing | 17 |
| Finding the Beginnings of Chapters or Tracks ... | 17 |
| Playing Still Frames (Pausing) | 17 |
| Frame-by-frame Playback | 17 |
| Slow Motion Playback | 17 |
| Chapter/Track/Title Repeat Playback | 17 |
| Searching by Title Number (DVD only) | 18 |
| Searching Directly by Chapter or Track Number | 18 |
| Switching the Angle (DVD only) | 18 |
| Switching the Audio Tracks | 18 |
| Switching the Subtitles (Subtitle Language) (DVD only) | 19 |
| Switching from the disc menu | 19 |
| Displaying the Disc Status for DVD | 19 |
| Displaying the Disc Status for Video CD | 19 |

Sound Setting

| | |
|--|----|
| Setting the MX mode | 20 |
| Setting the Bass Engine | 21 |
| Setting the Bass Control | 21 |
| Setting the Treble Control | 21 |
| About the Time Correction | 22 |
| Bass Focus | 22 |
| Time Correction | 23 |
| Adjusting the Built-in Crossover | 23 |
| Subwoofer On and Off | 23 |

Other Useful Features

| | |
|--|----|
| Titling Radio Stations/Discs | 24 |
| Displaying the Title List | 24 |
| Setting of Scrolling | 25 |
| Rear Enter Function | 25 |
| Switching the function of the remote sensor ... | 25 |
| Blackout Mode On and Off | 26 |
| Demonstration | 26 |
| Switching Display Modes | 26 |
| Displaying the Spectrum Analyzer | 27 |
| Switching the Visual Source Only (Simul Function) | 27 |

Setup

DVD Setup

| | |
|--|----|
| DVD Setup Operation | 28 |
| Changing the language setting | 28 |
| Setting of the Menu Language | 28 |
| Setting of the Audio Language | 28 |
| Setting of the Subtitle Language | 29 |
| Changing the Country Code Setting | 29 |
| Setting the Rating Level (Parental Lock) | 29 |
| Changing the Digital Output Setting | 30 |
| Setting the Digital Output | 31 |
| Setting the TV Screen Setting | 31 |

GENERAL Setup

| | |
|---|----|
| General Setup Operation | 31 |
| Setting Automatic Opening/Closing of the Monitor | 32 |
| Setting Visual Mode | 32 |
| Playing MP3 Data | 32 |
| Sound (Beep) Guide Function | 32 |
| Displaying the Time | 32 |
| Setting the Time | 32 |
| Setting Daylight Saving Time | 32 |
| Switching the Incoming Calls of the Telephone | 32 |

SYSTEM Setup

| | |
|--|----|
| System Setup Operation | 33 |
| Navigation Interruption and Adjusting its Volume | 33 |
| Setting the Navigation Mode | 33 |
| Setting the AUX Mode | 33 |
| Name External Equipment to be Displayed | 34 |
| Setting of the Rear Camera | 34 |
| Setting of the External Monitor Output | 34 |
| Setting the External Device Interrupt Mode ... | 34 |
| Setting the Interrupt Icon Display | 34 |
| Optical Digital Input Selection for an External Audio Processor | 34 |

DISPLAY Setup

| | |
|---|----|
| Display Setup Operation | 35 |
| Illumination Control | 35 |
| Adjusting Brightness | 35 |
| Adjusting Tint of Picture | 35 |
| Adjusting Color of Picture | 35 |
| Switching Background Textures | 35 |
| Setting Automatic Background Textures | 35 |

Navigation System (Optional)

| | |
|--|----|
| Controlling the Navigation System (Optional) ... | 36 |
|--|----|

Auxiliary Device (Optional)

| | |
|--|----|
| Operating Auxiliary Devices (Optional) | 36 |
|--|----|

Changer (Optional)

| | |
|--|----|
| Controlling CD Changer (Optional) | 37 |
| Multi-Changer Selection (Optional) | 38 |

XM Radio (Optional)

| | |
|--|----|
| Receiving XM Channels with the XM Receiver (Optional) | 38 |
| Tuning in to Categorized Programs | 39 |
| Changing the Display | 39 |
| Checking the XM Radio ID Number | 39 |
| Storing XM Channel Presets | 39 |
| Receiving Stored XM Channels | 39 |
| Displaying the Category/Channel Name Title List | 40 |

MobileHub™ Link (Optional)

| | |
|---|----|
| About MobileHub™ Link (Optional) | 40 |
| Telephone Reception | 41 |
| Calling | |
| Calling by using the Speed Dial | 41 |
| Dial call | 41 |
| Calling by the address book | 42 |
| Calling by the outgoing / incoming / absent incoming history | 42 |
| SMS (Short Message Service) Operation | |
| Receiving a Short Message | 42 |
| Sending a standardized sentence | 43 |

External Audio Processor (Optional)

| | |
|--|----|
| Adjustment Procedure for Dolby Surround | 44 |
| Setting the Speakers | 45 |
| Set MX Mode of the External Audio Processor | 45 |
| X-OVER Adjustment | 46 |
| Performing Time Correction Manually (TCR)/ Swithing the Phase | 46 |
| Graphic Equalizer Adjustments | 47 |
| Parametric Equalizer Adjustments | 47 |
| BASS COMP. Setting | 48 |
| Bass Focus | 48 |
| Speaker Setup | 48 |
| Setting of Dolby 5.1ch | 49 |
| Adjusting the acoustic image | 49 |
| Mixing bass sound to the rear channel | 49 |
| Achieving powerful high volume sound | 49 |
| Adjusting the speaker levels | 50 |
| Adjusting the DVD Level | 50 |
| Storing Settings in the Memory | 50 |
| Getting out the Preset Memory | 50 |
| Using the ProLogic II Mode | 51 |
| Linear PCM Setting | 51 |

Remote Control

| | |
|---|----|
| Operating for the IVA-D900 | 52 |
| Operating the DVD player/DVD changer (sold separately) | 54 |
| Operating the Navigation (sold separately) | 55 |
| Operating a separately sold TV monitor | 55 |
| Battery Replacement | 56 |
| Notes on Using the Remote Control | 56 |

Information

| | |
|------------------------------|----|
| About DVDs | 57 |
| Terminology | 58 |
| List of Language Codes | 59 |
| List of Country Codes | 60 |
| In Case of Difficulty | 62 |
| Specifications | 66 |

Installation and Connections



WARNING

| | |
|--|-----------|
| WARNING | 67 |
| CAUTION | 67 |
| PRECAUTIONS | 67 |
| Installation | 68 |
| Connections (IVA-D900 Wiring Diagram) | 71 |
| System Example | 73 |

LIMITED WARRANTY

Operating Instructions

WARNING



This symbol means important instructions. Failure to heed them can result in serious injury or death.

INSTALL THE PRODUCT CORRECTLY SO THAT THE DRIVER CANNOT WATCH TV/VIDEO UNLESS THE VEHICLE IS STOPPED AND THE EMERGENCY BRAKE IS APPLIED.

It is dangerous (and illegal in many states) for the driver to watch TV/Video while driving a vehicle. Installing this product incorrectly enables the driver to watch TV/Video while driving. This may cause a distraction, preventing the driver from looking ahead, thus causing an accident. The driver or other people could be severely injured.

DO NOT WATCH VIDEO WHILE DRIVING.

Watching the video may distract the driver from looking ahead of the vehicle and cause an accident.

DO NOT OPERATE ANY FUNCTION THAT TAKES YOUR ATTENTION AWAY FROM SAFELY DRIVING YOUR VEHICLE.

Any function that requires your prolonged attention should only be performed after coming to a complete stop. Always stop the vehicle in a safe location before performing these functions. Failure to do so may result in an accident.

KEEP THE VOLUME AT A LEVEL WHERE YOU CAN STILL HEAR OUTSIDE NOISE WHILE DRIVING.

Failure to do so may result in an accident.

MINIMIZE DISPLAY VIEWING WHILE DRIVING.

Viewing the display may distract the driver from looking ahead of the vehicle and cause an accident.

DO NOT DISASSEMBLE OR ALTER.

Doing so may result in an accident, fire or electric shock.

USE ONLY IN CARS WITH A 12 VOLT NEGATIVE GROUND.

(Check with your dealer if you are not sure.) Failure to do so may result in fire, etc.

KEEP SMALL OBJECTS SUCH AS BATTERIES OUT OF THE REACH OF CHILDREN.

Swallowing them may result in serious injury. If swallowed, consult a physician immediately.

USE THE CORRECT AMPERE RATING WHEN REPLACING FUSES.

Failure to do so may result in fire or electric shock.

DO NOT BLOCK VENTS OR RADIATOR PANELS.

Doing so may cause heat to build up inside and may result in fire.

USE THIS PRODUCT FOR MOBILE 12V APPLICATIONS.

Use for other than its designed application may result in fire, electric shock or other injury.

DO NOT PLACE HANDS, FINGERS OR FOREIGN OBJECTS IN INSERTION SLOTS OR GAPS.

Doing so may result in personal injury or damage to the product.



This symbol means important instructions. Failure to heed them can result in injury or material property damage.

HALT USE IMMEDIATELY IF A PROBLEM APPEARS.

Failure to do so may cause personal injury or damage to the product. Return it to your authorized Alpine dealer or the nearest Alpine Service Center for repairing.

DO NOT MIX NEW BATTERIES WITH OLD BATTERIES. INSERT WITH THE CORRECT BATTERY POLARITY.

When inserting the batteries, be sure to observe proper polarity (+ and -) as instructed. Rupture or chemical leakage from the battery may cause fire or personal injury.

KEEP FINGERS AWAY WHILE THE MOTORIZED FRONT PANEL OR MOVING MONITOR IS IN MOTION.

Failure to do so may result in personal injury or damage to the product.

PRECAUTIONS

Temperature

Be sure the temperature inside the vehicle is between +45°C (+113°F) and 0°C (+32°F) before turning your unit on.

Moisture Condensation

You may notice the disc playback sound wavering due to condensation. If this happens, remove the disc from the player and wait about an hour for the moisture to evaporate.

Damaged Disc

Do not attempt to play cracked, warped, or damaged discs. Playing a bad disc could severely damage the playback mechanism.

Maintenance

If you have problems, do not attempt to repair the unit yourself. Return it to your Alpine dealer or the nearest Alpine Service Station for servicing.

Never Attempt the Following

Do not grip or pull out the disc while it is being pulled back into the player by the automatic reloading mechanism. Do not attempt to insert a disc into the unit when the unit power is off.

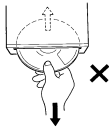

Inserting Discs

Your player accepts only one disc at a time for playback. Do not attempt to load more than one disc.

Make sure the label side is facing up when you insert the disc. Your player will automatically eject any disc that is inserted incorrectly. If the player continues to eject a correctly inserted disc, push the RESET switch with a pointed object such as a ballpoint pen.

Playing a disc while driving on a very bumpy road may result in skips, but this will not scratch the disc or damage the player.

New Discs

As a protective measure to prevent the disc from jamming, the DVD player will automatically eject discs with irregular surfaces or inserted incorrectly. When a new disc is inserted into the player and ejected after initial loading, using your finger, feel around the inside of the center hole and outside edge of the disc. If you feel any small bumps or irregularities, this could inhibit proper loading of the disc. To remove the bumps, rub the inside edge of the hole and outside edge of the disc with a ball-point pen or other such instrument, then insert the disc again.

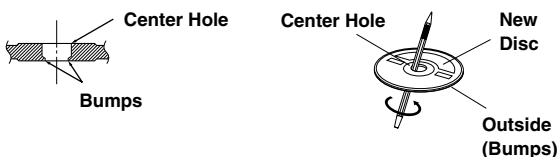

Irregular Shaped Discs

Be sure to use round shaped discs only for this unit and never use any special shaped discs.

Use of special shaped discs may cause damage to the mechanism.

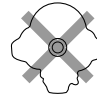

Installation Location

Make sure the IVA-D900 will not be installed in a location subjected to:

- Direct sun and heat
- High humidity and water
- Excessive dust
- Excessive vibrations

Correct Handling

Do not drop the disc while handling. Hold the disc so you will not leave fingerprints on the surface. Do not affix tape, paper, or gummed labels to the disc. Do not write on the disc.

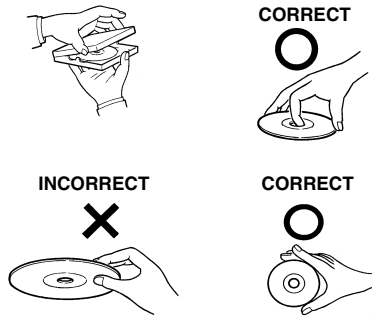

Disc Cleaning

Fingerprints, dust, or soil on the surface of the disc could cause the DVD player to skip. For routine cleaning, wipe the playing surface with a clean, soft cloth from the center of the disc to the outer edge. If the surface is heavily soiled, dampen a clean, soft cloth in a solution of mild neutral detergent before cleaning the disc.



Continued

Disc Accessories

There are various accessories available on the market for protecting the disc surface and improving sound quality. However, most of them will influence the thickness and/or diameter of the disc. Using such accessories can cause operational problems. We recommend not using these accessories on discs played in Alpine DVD players.



Transparent Sheet



Disc Stabilizer

Handling the Detachable Front Panel

- Do not expose to rain or water.
- Do not drop or subject to shock.
- After turning the system off, a slight ghost of the image will remain temporarily. This is an effect peculiar to LCD technology and is normal.
- In cold temperature conditions, the screen may lose contrast temporarily. After a short warm-up period, it will return to normal.

Alpine products equipped with the Ai-NET bus, connected to the IVA-D900, can be operated from the IVA-D900. Depending on the products connected, the functions and displays will vary. For details, consult your Alpine dealer.

Remove the anti-theft cover when you drive. This prevents the cover from falling off the unit and interfering with the safe operation of the vehicle.

Operation of some of the functions of this unit is very complex. Because of this, it was deemed necessary to place these functions into a special screen. This will restrict operation of these functions to times when the vehicle is parked. This ensures the focus of the driver's attention will be on the road and not on the IVA-D900. This has been done for the safety of the driver and passengers.

Title Input and Audio Processor Adjustments cannot be made if the car is moving. The car must be parked and the parking brake must be engaged for the procedure described in the Owner's Manual to be valid. The warning "CAN'T OPERATE WHILE DRIVING," will be displayed if any attempts are made to perform these operations while driving.

This operation is the same as when selecting sources using the remote control. When the car is parked, the selection is made as described in the Owner's Manual.

Discs playable on this unit

Playable Discs

The discs listed below can be played on this unit.

| | Mark (logo) | Recorded content | Disc size | Max. playing time |
|--------------|-------------|---------------------------------|------------------|---------------------------------------|
| DVD Video | | Audio + Video (Moving pictures) | 12 cm* | One-sided disc Approx. 4 hours |
| | | | | Two-sided disc Approx. 8 hours |
| | | | 8 cm | One-sided disc Approx. 80 Minutes |
| | | | | Two-sided disc Approx. 160 Minutes |
| Video CD | | Audio + Video (Moving pictures) | 12 cm | Approx. 74 Minutes |
| | | | 8 cm | Approx. 20 Minutes |
| Music CD | | Audio | 12 cm | Approx. 74 Minutes |
| | | | 8 cm (CD single) | Approx. 20 Minutes |

* Two-layer DVD disc compatible

If you use unspecified compact discs, correct performance cannot be guaranteed.

You can play CD-Rs (CD-Recordable)/CD-RWs (CD-Rewritable) which have been recorded only on audio devices. You can also play CD-Rs/CD-RWs containing MP3 formatted audio files.

- Some of the following Discs may not play on this unit:
Flawed Discs, Discs with fingerprints, Discs exposed to extreme temperatures or sunlight (e.g., left in the car or this unit), Discs recorded under unstable conditions, Discs on which a recording failed or a re-recording was attempted, copy-protected CDs which do not conform to the audio CD industry standard.
- Use discs with MP3 files written in the format compliant with ISO 9660 level 1 or level 2. For details, see pages 13 and 14.

To customers using CD-R/CD-RW

- If a CD-R/CD-RW cannot be played back, make sure the last recording session was closed (finalized).
- Finalize the CD-R/CD-RW if necessary, and attempt playback again.

Tips for making your own CDs

The IVA-D900 plays DVD Video, Video CD, Audio CD and has a built in MP3 decoder.

The following information is designed to help you create your own music CDs (either Audio CD or MP3 encoded CD-R/RW files).

What is the difference between an Audio and MP3 CD?

An Audio CD is the same format as the commercial CDs you buy in the store (also known as CD-DA). MP3 (MPEG Audio Layer 3) is a data file that uses a compression scheme to reduce the size of the music file.*

Hybrid Audio CD and Data (MP3) CD-R/RW discs:

The IVA-D900 can read either sector on the disc. Choose MixDisc CD to play the CD audio section or MixDisc MP3 to play the MP3 section.*

Multisession CD-R/RW:

Once a recording has been stopped, this is considered one session. If the disc is not closed (finalized), additional data may be added. Once this additional data has been recorded, this becomes a "multisession" CD. The IVA-D900 can only read multisession DATA Formatted discs (MP3 files - Not Audio CD files).

MP3 ID3 Tag Information:

The IVA-D900 read and displays MP3 ID3v1 tag information. MP3 files created with ID3v2 tag information can be played back but the tag info cannot be read or displayed.

Properly formatted MP3 Discs:

Use ISO-9660 formatting to insure proper playback. You may use standard ISO naming Level 1 (8.3 DOS standard), Level 2 (32 characters) or Joliet, (Windows or Macintosh long filenames) file naming conventions.*

*Please consult the Owner's manual for additional information.

On handling Compact Discs (CD/CD-R/CD-RW)

- Do not touch the surface.
- Do not expose the disc to direct sunlight.
- Do not affix stickers or labels and do not write on the surface.
- Clean the disc when it is dusty.
- Make sure that there are no bumps around the disc.
- Do not use commercially available disc accessories.

Do not leave the disc in the car or the unit for a long time.

Never expose the disc to direct sunlight.

Heat and humidity may damage the disc and you may not be able to play it again.

Discs that cannot be played

DVD-ROMs, DVD-R/DVD-RAMs, DVD-RWs, DVD + RWs, CD-ROMs (excluding MP3 files), photo CDs, etc.

DVD region number (playable region number)

This DVD head unit will play back any disc whose region number is 1 (or All). DVDs with a region number other than those listed below, cannot be played on this DVD player.



Video CDs

This DVD head unit is compatible with playback control (PBC) compatible video CDs (version 2.0).

"PBC" is a function by which you can use menu screens recorded on the disc to find the scene you want to watch and view various types of information in dialog style.

Disc terminology

Title

If titles are programmed for the DVD, these are the largest units of division of the information recorded on the disc.

Chapter

Each Title may also be divided into smaller divisions called Chapters. These can be specific scenes or musical selections.

* *This product incorporates copyright protection technology that is protected by method claims of certain U.S. patents and other intellectual property rights owned by Macrovision Corporation and other rights owners. Use of this copyright protection technology must be authorized by Macrovision Corporation, and is intended for home and other limited viewing uses only unless otherwise authorized by Macrovision Corporation. Reverse engineering or disassembly is prohibited.*

* *Manufactured under license from Dolby Laboratories. "Dolby," "Pro Logic" and the double-D symbol are trademarks of Dolby Laboratories. Confidential unpublished works. ©1992-1997 Dolby Laboratories. All rights reserved.*

* *"DTS" is a registered trademark of Digital Theater Systems, Inc.*

Getting Started

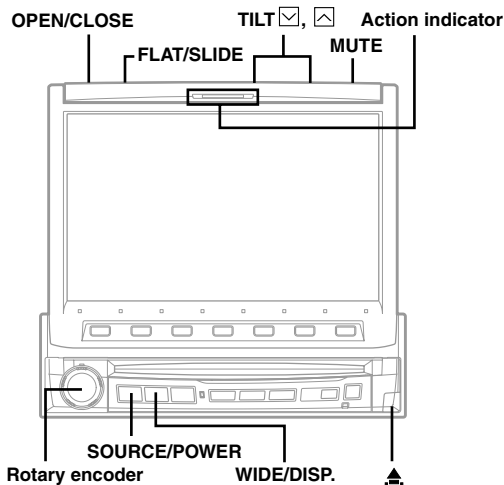

Basic Operation

This section describes the basic operation of the DVD. These operations also apply to the other sources.

1 Press SOURCE/POWER on the unit to turn the power on.

2 Press OPEN/CLOSE to open the monitor.
The unit beeps 3 times and raises the monitor. The opening screen appears on the monitor.

3 Press SOURCE/POWER.
The display shows the main menu screen.

4 Turn the Rotary encoder and select "DVD PLAYER" from the main menu.

- If an optional DVD player or DVD Changer is connected and its power is on, the display shows "[EXT.DVD]" or "[DVD CHG] , [AUX2]" instead of "[AUX1] [AUX2] ."
- If both the optional DVD player and DVD Changer are connected, the display shows "[EXT.DVD]" instead of "[AUX1]", and "[DVD CHG]" instead of "[AUX2]" .

5 Press the Rotary encoder to execute the selection.

The DVD player mode screen is displayed.
(The DVD disc is played back.)

- If PAGE 1/2 or PAGE 1/3 appears in the Function Guide menu, there are additional functions available for the selected source. Access these functions by pressing [7].

6 Press SOURCE/POWER again to select another source.

Tip

The action indicator always lights up except for the following cases.

- Blinks when the monitor opens or closes.
- Blinks when the answer phone has a message. (Only when Mobile Hub (CXA-B200NK) is connected.)
- Does not light up when the Illumination Control (Dimmer) is set to ON.

DVD Mode Screen



*Tip

- 1 Press and hold **WIDE/DISP.** for more than 2 seconds.
The working indicator display in the mode main screen is switched to the spectrum analyzer display.
- 2 Press and hold again **WIDE/DISP.** for more than 2 seconds to return to the working indicator display.

Compatibility with Factory Steering Wheel Radio Controls



If your vehicle has steering wheel controls for the radio, an optional steering wheel control interface may be available to connect to your Alpine radio. For details, contact your Alpine dealer.

Turning Power On or Off

Some of this unit's functions cannot be performed while the vehicle is in motion. Be sure to stop your vehicle in a safe location and apply the parking brake, before attempting these operations.

1 Press **SOURCE/POWER** to turn on the unit.

The opening screen appears automatically.

- The unit can be turned on by pressing any button on the unit except the **FLAT/SLIDE**, **OPEN/CLOSE**, **TILT**   and  (Eject).

2 Press and hold **SOURCE/POWER** for at least 2 seconds to turn off the unit.

- The IVA-D900 draws minimal current even when its power switch is turned off. If the switched power (ignition) lead of the IVA-D900 is connected directly to the positive (+) post of the vehicle's battery, the battery may be discharged. If this lead is unswitched, it must be disconnected from the battery post should the vehicle be left unused for an extended period of time.

An SPST (Single-Pole, Single-Throw) switch (sold separately) can be added to simplify this procedure. Then, you can simply place it in the OFF position when you leave the vehicle. Turn the SPST switch back ON before using the IVA-D900. For connecting the SPST switch, refer to the "Connection Diagram of SPST switch" (page 70).

- Some operation of the unit cannot be performed while the vehicle is in motion. In this case, be sure to first stop your vehicle and apply the parking brake, then perform the operation.

Detaching and Attaching the Front Panel

Detaching

- 1 Turn off the unit power.
- 2 Press  (Release) at the lower right side until the front panel pops out.
- 3 Grasp the right side of the front panel, lift it up slightly then pull it out.

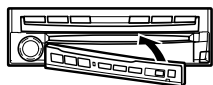

- The front panel may become hot in normal usage (especially the connector terminals on the back of the front panel.) This is not a malfunction.
- To protect the front panel, place it in the supplied carrying case.

Attaching

- 1 Insert the left side of the front panel into the main unit. Align the groove on the front panel with the projections on the main unit.
- 2 Push the right side of the front panel until it locks firmly into the main unit.

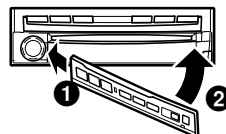

- Before attaching the front panel, make sure that there is no dirt or dust on the connector terminals and no foreign object between the front panel and the main unit.
- Attach the front panel carefully, holding the sides of the front panel to avoid pushing buttons by mistake.

Initial System Start-Up

Immediately after installing or applying power to the unit, it should be initialized. To do this, first, remove the detachable front panel. Behind the front panel, to the left of the connector, there is a small hole.

Using a pencil or other pointed object, press the reset switch mounted behind this hole to complete the initialization procedure.



RESET switch

- Any of the buttons does not function while the monitor is closing by reset.

Raising/Lowering the Monitor

Press **OPEN/CLOSE**.

The unit beeps 3 times and raises (or lowers) the monitor automatically.

- The IVA-D900 is a precision device. With gentle handling, its unique capabilities can be enjoyed for a long time.
- If the monitor touches an obstacle while it is being raised (or lowered), the unit will stop raising (or lowering) the monitor immediately. Should this occur, remove the obstacle and press **OPEN/CLOSE** again to lower the monitor.
- When the movable monitor is opened, do not place any object on the monitor and be careful not to bump or apply any pressure to the monitor while it is open. This can cause damage to the mechanism.
- In low ambient temperature conditions, the display may be dark for a short period of time immediately after the power is turned on. Once the LCD has warmed up, the display returns to normal.
- For your safety, some operation of the unit cannot be performed while the vehicle is in motion. In this case, first stop the vehicle and engage the parking brake, then perform the operation.
- Operation of the remote control (pages 52-55) can be carried out even while the monitor screen is closed.

Selecting the Monitor Opening Angle

The monitor opening angle can be set in 2 positions.



Press and hold FLAT/SLIDE for at least 2 seconds while the monitor is being raised.

Each press changes the monitor angle back or forth.





- *When the back-and-force adjustment of the monitor is interrupted by something cutting in, the monitor functions only opening or closing.*

Adjusting the Monitor Viewing Angle

Adjust the monitor's angle for better visibility.

Press TILT  and  to adjust the monitor's angle so the screen will be in the best viewing position.

Pressing the buttons produces a beep and changes the screen angle between 40 and 105 degrees.

- *By pressing TILT  or  and holding, the angle changes continuously.*
- *If the monitor touches an obstacle while the angle is being adjusted the unit stops the screen immediately. Should this happen, remove the obstacle and press TILT  or  again.*
- *The screen color will vary when viewed at certain angles. Adjust the screen angle for the best viewing position.*
- *If the voltage of the vehicle's battery power is low, the screen may blink when the screen angle is changed. This is normal and not a malfunction.*

Moving the monitor to be Flat

When you want to operate some function on the car (air conditioner, etc.) which is hidden by the raised monitor, use this function.

1 Press FLAT/SLIDE.

The monitor moves to the flat position.

2 Press FLAT/SLIDE again.

The monitor returns to the previous angle.

- *The monitor returns to the previous angle from being flat after 10 seconds.*
- *If an excessive force is added to the monitor when the monitor is flat, putting an object on the back of the monitor for example, it may cause a malfunction.*

Adjusting the Volume/Balance (Between Left and Right)/Fader (Between Front and Rear)/Defeat

1 Press the Rotary encoder repeatedly until the mode you wish to adjust is obtained.

Each press changes the modes as follows:

VOL. → NAV.* → SUB W.* → BAL. → FAD. → DEFEAT → VOL.

* NAV. (page 33) and SUBW. (page 23) cannot be adjusted while they are set to OFF.

| | |
|------------|-----------|
| Volume: | 0 - 35 |
| Balance: | L15 - R15 |
| Fader: | F15 - R15 |
| Subwoofer: | 0 - 15 |
| NAV. MIX: | 0 - 15 |
| DEFEAT: | ON/OFF |

The volume level can be adjusted at any time by just turning the **Rotary encoder**.

2 Turn the Rotary encoder to set to the desired sound within 5 seconds after selecting the mode.

By setting Defeat ON, previously adjusted settings of BASS and TREBLE will return to the factory defaults, but MX will be turned off.

- *If the Rotary encoder is not turned or pressed within 5 seconds after selecting the Balance, Fader, Defeat and Subwoofer mode, the unit automatically defaults back to the Volume mode.*

Lowering Volume Quickly

Activating this function will instantly lower the volume level by 20 dB.

Press MUTE to activate the MUTE mode.

The audio level decreases by about 20 dB.

Pressing **MUTE** again brings the audio back to its previous level.

Radio

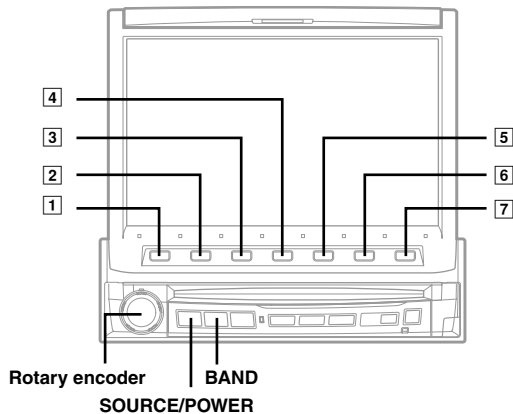

Listening to the Radio

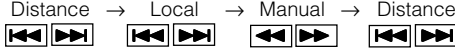
- 1 Press SOURCE/POWER.**
The main menu screen appears.
 - 2 Turn the Rotary encoder to select "RADIO," then press the Rotary encoder.**
The radio mode is activated and the display changes to the Radio Mode screen.
 - 3 Press BAND to select the desired radio band.**
Each press changes the bands as follows:
FM1 → FM2 → AM → FM1
 - 4 Press 2 (TUNE) to choose the tuning mode.**
Each press changes the function modes for the buttons 1 and 3 as follows:
Distance → Local → Manual → Distance

- There are two modes you can select for auto tuning, DX and Local:
 - DX (Distance) mode (with DX SEEK indicator ON);
Both strong and weak stations will be tuned in.
 - Local mode (with SEEK indicator ON);
Only strong stations will be tuned in.The initial setting is DX.
- 5 Press 1 (◀◀) or 3 (▶▶) to change the radio frequency downward or upward respectively.**
When the button is pressed and held, the frequency changes continuously until the button is released.
- When a stereo FM station is tuned in, the STEREO indicator appears in the display.

Manual Storing of Station Presets

- 1 Tune in a desired radio station you wish to store in the preset memory by manual or automatic seek tuning.**
 - 2 Press 7 (PAGE 1/2).**
 - 3 Press and hold any one of the Function buttons 1 (P.SET1) through 6 (P.SET6) for at least 2 seconds.**
The selected station is stored.
 - 4 Repeat the procedure to store up to 5 other stations onto the same band.**
To use this procedure for other bands, simply select the band desired and repeat the procedure.

A total of 18 stations can be stored in the preset memory (6 stations for each band; FM1, FM2, AM).
- If a preset memory has already been set in the same Function button, it will be cleared and the new station will be memorized.

Automatic Memory of Station Presets

The tuner can automatically seek and store 6 strong stations in the selected band in order of signal strength.

- 1 Press BAND in the radio mode to select the desired radio band.**
 - 2 Press 6 (A.MEMO).**
The tuner automatically seeks and stores 6 strong stations into 1 (P.SET1) to 6 (P.SET6) in order of signal strength. When the automatic storing has been completed, the tuner goes to the station stored in 1 (P.SET1).
- If no stations are stored, the tuner will return to the original station you were listening to before the automatic storing procedure began.

Tuning to Preset Stations

You can tune in the preset stations in memory on each band using the Function buttons.

- 1 Press BAND in the radio mode to choose the desired radio band.**
- 2 Press 1 (P.SET1) through 6 (P.SET6) that has your desired preset station in memory.**
The preset station is received.

CD/MP3

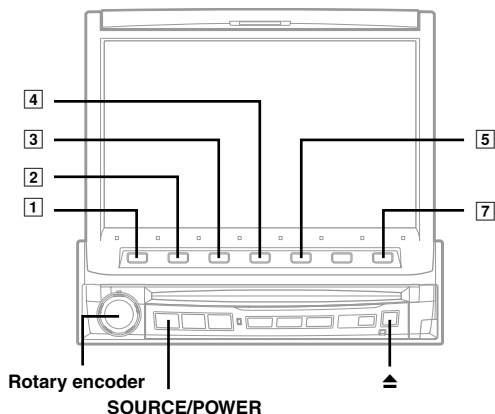

Playback

1 Press **SOURCE/POWER** to display the main menu screen.

2 Turn the **Rotary encoder** and select the **DVD player mode**. Then, press the **Rotary encoder** to execute the selection.

The display shows the DVD player mode screen.

When a CD/MP3 is inserted into the DISC SLOT of the IVA-D900, with the label side facing up, the unit starts to play the CD/MP3.

- During CD play:

On the upper line of the DISC INFO (Disc Information), the Track TEXT* is displayed.

On the lower line, the input title is displayed. When no title is input, the DISC TEXT* is displayed.

* When a CD TEXT is inserted.

- During MP3 play:

On the upper line of the DISC INFO (Disc Information), the file name is displayed at first, then the track name is displayed if ID3TAG information is contained.

On the lower line, the folder name is displayed at first, then the artist name and the album name is displayed if ID3TAG information is contained.

- When an optional Alpine CD player is connected, inserting a CD into the optional CD player starts playback automatically.

- When an optional Alpine MD player is connected to the IVA-D900, you can control the player from the IVA-D900. (When the MDA-5051 is connected, MDs can be played back only.)

3 Press **[1] (◀◀)** or **[3] (▶▶)** to select the desired track (file).

Returning to the beginning of the current track (file):

Press **[1] (◀◀)**.

Fast backward :

Press and hold **[1] (◀◀)**.

Advancing to the beginning of the next track (file) :

Press **[3] (▶▶)**.

Fast forward :

Press and hold **[3] (▶▶)**.

To pause playback

Press **[2] (▶||)**.

Pressing **[2] (▶||)** again will resume playback.

To eject the disc

Press **▲**.

If you use an optional CD player, press the eject button on the optional CD player.

- The IVA-D900 models include a built-in MP3 unit. You can play CD-ROMs, CD-Rs, and CD-RWs containing MP3 files on this unit. Use the format compliant with ISO 9660 level 1 or level 2. For further information about playing or storing MP3 files, refer to pages 13 and 14 before using the unit.
- The unit can play discs containing both audio data and MP3 data.
- The MP3 indicator is lit during MP3 playback.
- The track display for CD audio data playback is the track numbers recorded on the disc.
- Three-inch (8cm) CD's can be used.
- "Playing MP3 Data" is mentioned on page 32 "GENERAL Setup".
- When an MP3 disc is played, it sometimes takes a few moment until it starts.

Repeat Play

Press **[4] (REPEAT)** to play back repeatedly the track being played.

The track (file) will be played repeatedly.

Press **[4] (REPEAT)** again and select OFF to deactivate the repeat play.

CD: REPEAT → *1REPEAT ALL → (off) → REPEAT

MP3: REPEAT → *2REPEAT FOLDER → *1REPEAT ALL → (off) → REPEAT

*1 If a CD Changer or an MP3 compatible CD changer is connected and the REPEAT ALL mode is selected, the unit repeatedly plays back all tracks (files) on the disc selected.

*2 Only files in a folder are repeatedly played back.

M.I.X. (Random Play)

Press **[5]** (M.I.X.) in the play or pause mode.

The tracks (files) on the disc will be played back in a random sequence.

To cancel M.I.X. play, press **[5]** (M.I.X.) again.

CD: M.I.X. → *M.I.X. ALL → (off) → M.I.X.

MP3: *²M.I.X. → (off) → M.I.X.

^{*1} If a CD Changer equipped with the M.I.X. ALL function is connected, M.I.X. ALL will also be selectable.
In this mode, the tracks on all the CDs in the current magazine will be included in the random playback sequence.

^{*2} If an MP3 compatible CD changer is connected, all files in a disc are played back in random sequence, and playback shifts to the next disc.

- To select the M.I.X. FOLDER mode:
(Only files in a folder are played back in random sequence.)
Press **[5]** (M.I.X.) after REPEAT FOLDER is selected.
The M.I.X. FOLDER mode is selected.

To cancel the M.I.X. FOLDER mode:

Press **[4]** (REPEAT) to cancel the REPEAT FOLDER.
The M.I.X. FOLDER mode is also canceled.

Selecting Folders (concerning MP3)

1 During MP3 play, press **[7]** (PAGE 1/2).

The Function Guide display changes.

2 Press **[1]** (◀ F. DN) or **[3]** (F. UP ▶) to select the folder.

About MP3

CAUTION

Except for personal enjoyment, duplicating audio data (including MP3 data) or distributing, transferring, or copying it, whether for free or for a fee, without the permission of the copyright holder is strictly prohibited by the Copyright Act and by international treaty.

What is MP3?

MP3, whose official name is "MPEG Audio Layer 3," is a compression standard prescribed by the ISO, the International Standardization Organization and MPEG which is a joint activity institution of the IEC.

MP3 files contain compressed audio data. MP3 encoding is capable of compressing the audio data at extremely high ratios shrinking music files by as much as one-tenth their original size. This is achieved while still maintaining near CD quality. The MP3 format realizes such high compression ratios by eliminating the sounds that are either inaudible to the human ear or masked by other sounds.

Method for creating MP3 files

The software used to create MP3 files is widely sold or free from various sources. For details on creating MP3 files, refer to the user's manual for that software.

The MP3 files that can be played back by this device have the file extension "mp3." Files with no extension can not be played back.

Supported playback sampling rates and bit rates

Sampling rates: 32 kHz - 48 kHz, bit rates: 32 - 320 kbps
Note that for sampling rates such as 22.05 kHz, this device may not display correctly.

ID3 tags

This device supports ID3 tag v1.
If ID3 tag data is in an MP3 file, this device can display the title (track title), artist name, and album name ID3 tag data.

This device can only display single-byte alphanumeric characters and the underscore.

Producing MP3 discs

MP3 files are prepared, then written to a CD-R or CD-RW using CD-R writing software. A disc can hold a maximum of 255 files, and 255 folders.

Media supported

The media that this device can play back are CD-ROMs, CD-Rs, and CD-RWs.

Corresponding File Systems

This device supports discs formatted with ISO9660 Level 1 or Level 2.

Under the ISO9660 standard, there are some restrictions to remember.
The maximum nested folder depth is 8 (including the root directory). File/folder names are limited to 31 characters (except the extension).
Valid characters for folder/file names are letters A-Z (all caps), numbers 0-9, and '_' (underscore).

This device also can play back discs in Joliet, and other standards that conform to ISO9660. However, sometimes the file names, folder names, etc., are not displayed correctly.

Formats supported

This device supports CD-ROM XA, Mixed Mode CD, Enhanced CD (CD-Extra) and Multi-Session. This device cannot correctly play back discs recorded with Track At Once or packet writing.

Order of tracks

The unit plays the files in the order that the writing software writes them. Therefore, the playing order may not be the same as the order you input. The playback order of the folders and files is as follows. However, the folder and file playback order differs from the folder no. and file no. indicated on the display.

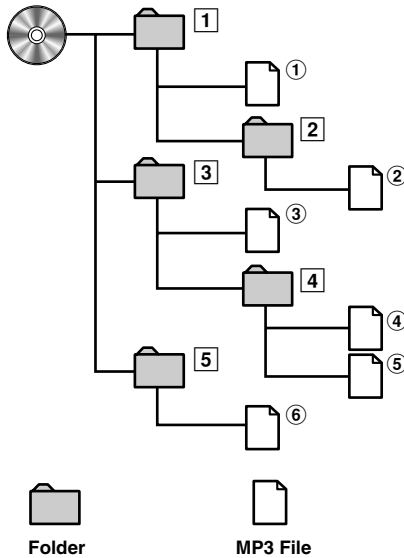

DVD/Video CD

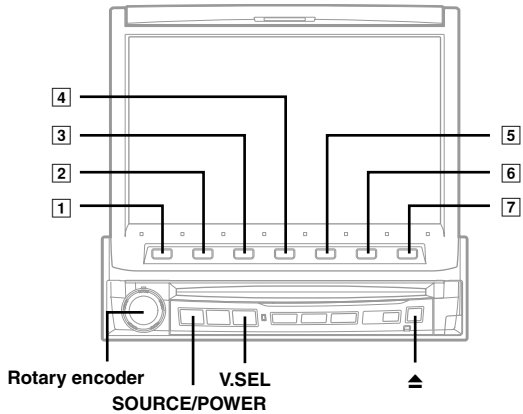

Playing DVD/Video CD

IVA-D900 has a built-in DVD player. When an optional Alpine DVD/video CD/CD player (or DVD changer) is connected to the IVA-D900, you can control it from the IVA-D900.



WARNING

It is dangerous (and illegal in many states) for the driver to watch the TV/Video while driving the vehicle. The driver may be distracted from looking ahead and an accident could occur.

Install the IVA-D900 correctly so that the driver cannot watch TV/Video unless the vehicle is stopped and the emergency brake is applied.

If the IVA-D900 is not installed correctly, the driver will be able to watch the TV/Video while driving the vehicle and may be distracted from looking ahead causing an accident. The driver or other people could be severely injured.

Terminology

Bit rate

This is the "sound" compression rate specified for encoding. The higher the bit rate, the higher the sound quality, but also the larger the files.

Sampling rate

This value shows how many times per second the data is sampled (recorded). For example, music CDs use a sampling rate of 44.1 kHz, so the sound level is sampled (recorded) 44,100 times per second. The higher the sampling rate, the higher the sound quality, but also the larger the volume of data.

Encoding

Converting music CDs, WAVE (AIFF) files, and other sound files into the specified audio compression format.

ID3 tag

Song information such as track titles, artist names, album names, etc., written into MP3 files.

To display the DVD mode screen

To watch a video source, your vehicle must be parked with the ignition key in the ACC or ON position. To do this, follow the procedure below.

1. Push the foot brake to bring your vehicle to a complete stop at a safe location. Engage the parking brake.
2. Keep pushing the foot brake and release the parking brake once then engage it again.
3. While the parking brake is being engaged the second time, release the foot brake.

- For automatic transmission vehicles, place the transmission lever in the Park position.

Now, the locking system for the DVD mode operation has been released. Engaging the parking brake can reactivate the DVD mode, as long as the car's ignition has not been turned off. It is not necessary to repeat the above procedure (1 through 3), of "To display the DVD mode screen."

Each time the ignition is turned OFF, perform the procedure of "To display the DVD mode screen."

- If you try to activate the auxiliary device while driving, the display will show the warning-**PICTURE OFF FOR YOUR SAFETY**.

Caution

- **Not all functions will operate for every DVD. See the individual DVD's instructions for details on the features supported.**
- **Fingerprints on a disc may adversely affect playback. If a problem occurs, remove the disc and check for fingerprints on the playback side. Clean the disc if necessary.**
- **If you switch the power or Ignition Key OFF or change sources during playback, playback will continue where you left off when you resume playback.**
- **If you try to perform an invalid operation (based on the type of disc being played), the following mark is displayed on the monitor screen: **

- **Play Position Memory Function**
Even if you turn power off or switch the Ignition Key to OFF during playback or change the source, playback will continue from the point where playback stopped when the power is turned ON again.

- 1 Press **SOURCE/POWER** to display the main menu screen.
- 2 Turn the **Rotary encoder** and select **DVD PLAYER** from the menu. Then, press the **Rotary encoder** to execute the selection.

The display shows the DVD player mode screen.

Insert a disc with the label side facing up. The unit starts to play the disc. The display shows the Function Guide.

When an optional Alpine DVD player is connected: Insert a disc into the DVD/video CD/CD player, the player starts playing.

To eject the disc

Press .

- Press  (**GUIDE**) during DVD/Video CD playback to turn on or off the Function Guide display.
In the ON position:
The Function Guide display will always be shown.
In the OFF position:
The Function Guide display will disappear after approx. 5 seconds if no button is pressed.
If you want to display the Function Guide screen again, press any one of the Function buttons.
- When the Function Guide display is ON, you cannot switch the display mode by pressing and holding **WIDE/DISP** for at least 2 seconds.
- The reverse side of a double-sided DVD will not be played automatically.
Remove the disc, turn it over, and reinsert it.
- **DO NOT** insert discs containing maps for the navigation system. Doing so could result in damage.
- When video CDs to which titles are input are inserted, the list of the titles can be displayed to select a desired disc (Displaying the title list, pages 24 and 25). A DVD disc cannot be titled. "DVD VIDEO" is displayed at the title list.
- Refer also to "DVD Setup" (pages 28 to 31).

Continued

If a menu screen appears

On DVDs and Video CDs with playback control (PBC), menu screens may appear automatically. If this happens, perform the operation described below to start playback.

DVD menu

- 1 Press **[7]**(PAGE 1/3) twice.
The Function Guide is switched.
- 2 Use **[1]**(←), **[2]**(↑), **[3]**(↓) or **[4]**(→) to select the desired item, then press **[5]**(ENTER).

- For some discs it is possible to select items directly from the menu screen using the number buttons (“0” to “9”) on the supplied remote control. Then, press **ENTER**.

Video CD menu

Use the number buttons (“0” to “9”) on the supplied remote control to select the desired number. Then, press **ENTER**.

When the PBC function is set to OFF, the menu screen is not displayed. In this case, set the PBC function to ON.

Operation from the remote control:

Press **MENU**.

Each pressing switches PBC ON and OFF.

Operation from the main unit button:

- 1 When the Video CD mode is selected, press **[5]**(PBC).
Each pressing switches PBC ON and OFF.
- 2 Press **[1]** (◀◀) or **[3]** (▶▶) to select a menu item.

In some discs, the DVD menu screen can be displayed.

Operation from the remote control:

Press **MENU**, or press and hold **TITLE** for more than 2 seconds.

Operation from the main unit buttons I:

- 1 When DVD mode is selected, press **[5]** (DVD MENU).
The Function Guide is switched.
- 2 Press **[1]** (←), **[2]** (↑), **[3]** (↓), **[4]** (→) or **[5]**(ENTER) to set the item.

Operation from the main unit buttons II:

- 1 When DVD mode is selected, press **[7]** (PAGE 1/3).
The Function Guide is switched.
 - 2 Press **[5]** (TITLE MENU).
 - 3 Press **[1]** (←), **[2]** (↑), **[3]** (↓), **[4]** (→) or **[5]** (ENTER) to set the item.
- By pressing **[6]** (DVD RETURN), the screen returns to the previous one.

To check the disc working status during play

- 1 Press **V.SEL** when your vehicle stops.
Each pressing switches the visual source.
The menu screen of the DVD mode is displayed.
Then disc working status can be checked.
- 2 Press **V.SEL** again to return DVD screen.
Each pressing switches the visual source.

< ex. DVD display >

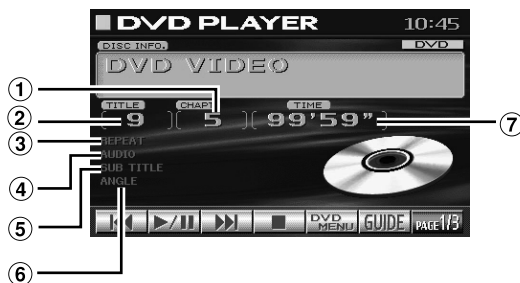

- ① Current chapter number
- ② Current title number
- ③ Repeat setting (Default setting-disc repeat)
- ④ Current audio stream
- ⑤ Current subtitle language
- ⑥ Current angle number
- ⑦ Elapsed playing time of current chapter

Stopping Playback (PRE STOP)

Press the stop button during playback to stop playback. That position is stored in the memory.

- 1 Press **[4]** (■) once during playback.
“PRE STOP” is displayed.

- 2 Press **[2]** (▶||) in the PRE STOP mode.
Playback starts from the position at which it was stopped.

- For some discs, the position at which playback was stopped may not be accurate.

Stopping Playback

Press **[4]** (■) twice or press once for more than 2 seconds during playback.

“STOP” is displayed, and playback stops.

- Playback stops even when ■ on the supplied remote control is pressed for more than 2 seconds.
- Playback starts from the beginning when **[2]** (▶||) is pressed while playback is stopped.

Fast-forwarding/Fast-reversing

- 1 During playback, press and hold [1] (⏮) (fast-reverse) or [3] (⏭) (fast-forward).**
When pressed for more than 1 second, the disc is forwarded/reversed at double speed.
When held in 5 more seconds, the disc is forwarded/reversed at 8 times the normal speed.
- 2 Release [1] (⏮) or [3] (⏭) to return to normal playback.**

- No sound or subtitles are played during fast-forwarding/fast-reversing.
- For DVDs and video CDs with playback control (PBC), the menu screen may reappear during fast-forwarding/fast-reversing.

Finding the Beginnings of Chapters or Tracks

- During playback, press [1] (⏮) or [3] (⏭).**
The chapter/track switches each time the button is pressed, and playback of the selected chapter/track starts.
- ▶▶: Press this to start playback from the beginning of the following chapter or track.
 - ◀◀: Press this to start playback from the beginning of the current chapter or track.

- Some DVDs do not have chapters.

Supplementary explanation

"Chapters" are divisions of movies or musical selections on DVDs.

"Tracks" are divisions of movies or musical selections on video and music CDs.

Playing Still Frames (Pausing)

- 1 During playback, press [2] (⏸) once.**
- 2 Press [2] (⏸) to resume playback.**

- No sound is played during the still frame mode.
- The image or sound may stop temporarily when playback starts from the pause mode. This is not a malfunction.

Frame-by-frame Playback

- 1 In the pause mode, press [3] (⏭).**
The picture advances by one frame each time the button is pressed.
- 2 Press [2] (⏸) to return to normal mode.**

- No sound is played during frame-by-frame playback.

Slow Motion Playback

- 1 When [3] (⏭) is pressed and held in while in the pause mode, the 1/8th speed slow motion playback mode is set.**
When held in for 5 more seconds, the slow motion speed switches to 1/2 the normal speed.
- 2 Release [3] (⏭) to pause, and press [2] (⏸) to playback.**

- No sound is played during slow motion playback.
- Reverse slow motion playback is not available.
- 1/2, 1/8 are approximate speeds. The actual speed differs from disc to disc.

Chapter/Track/Title Repeat Playback

Use this function to play the disc's titles, chapters or tracks repeatedly.

DVD

- 1 During playback, press [7] (PAGE 1/3).**
- 2 Press [4] (REPEAT) on the main unit.**
The repeat mode switches each time the button is pressed.

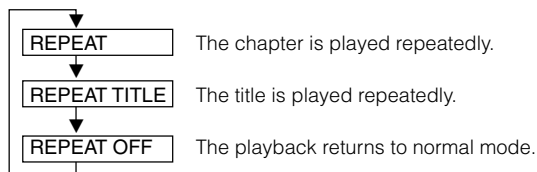

Video CD

- 1 During playback, press [4] (REPEAT) on the main unit.**
The repeat mode switches each time the button is pressed.

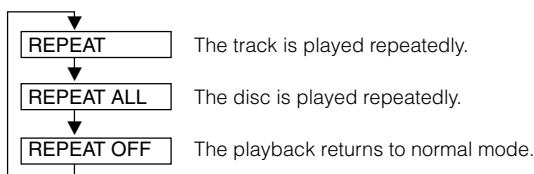

- The track/disc repeat modes cannot be used on video CDs with playback control (PBC). Follow the operation below to turn PBC to OFF.

Operation from the remote control:

Press **MENU**.

Each press switches between PBC ON and OFF.

Operation from the main unit button:

- 1 When the Video CD mode is selected, press [5] (PBC).
Each press switches between PBC ON and OFF.
- 2 Press [1] (⏮) or [3] (⏭) to select a menu item.

- For some discs it is not possible to switch the repeat mode.

Searching by Title Number (DVD only)

Use this function to easily find positions on the DVD using the DVD's titles.

1 When the playback stops, input the number of the title you want to play using the number buttons ("0" to "9") on the supplied remote control.

- This function cannot be used on discs on which no title numbers are recorded.
- Press **DEL.** to delete the last digit in the title number. Press and hold **DEL.** for at least 2 seconds to clear all title numbers.
- Press **RTN** to cancel the title search mode and resume normal playback.
- The playback starts automatically for two digit title numbers even if **ENTER** in procedure 2 is not pressed.
- Playback starts from the beginning of the chapter/track number in the state of **PRE STOP**.
- Some disc may not accept any operation.

2 Press **ENTER**.

Playback starts from the selected title number.

Searching Directly by Chapter or Track Number

Use this function to easily move to the beginnings of the chapters or tracks on the disc.

1 Press **[5] (DVD MENU)** except when playback stops.

DVD menu screen is displayed.

2 Press **[7] (PAGE 1/3)** twice.

The Function Guide is switched.

3 Press **[1] (←)** through **[4] (→)** to select a chapter or a track to be played.

4 Press **[5] (ENTER)**.

Playback starts from the selected chapter or track.

- While the DVD title menu is displayed also by pressing **[5] (TITLE MENU)**, in some disc, either **[5] (DVD MENU)** or **[5] (TITLE MENU)** may not be effective for it.
- This function cannot be used on discs on which no chapter numbers are recorded.

Operation from the remote control

1 Except during the stop mode, input the number of the chapter or track you want to play using the number buttons ("0" to "9").

2 Press **ENTER**.

Playback starts from the selected chapter or track.

- If the track number is a 2-digit number, playback starts automatically even if **ENTER** is not pressed in step 2.
- If the chapter number is a 3-digit number, playback starts automatically even if **ENTER** is not pressed in step 2.
- Press **DEL.** to delete the last digit in the chapter/track number. Press and hold **DEL.** for at least 2 seconds to clear "Chapter" and "Track" numbers.
- Press **RTN** to cancel the chapter/track search mode and resume normal playback.
- With video discs containing playback control (PBC), the "searching directly by track number" function is not available while PBC is ON. Follow the operation below to turn PBC to OFF.
Operation from the remote control:
Press **MENU**.
Each press switches between PBC ON and PBC OFF.
Operation from the main unit button:
1 When the Video CD mode is selected, press **[5] (PBC)**.
Each press switches between PBC ON and PBC OFF.
2 Press **[1] (◀◀)** or **[3] (▶▶)** to select a menu item.
- If the chapter/track number is known, you can search directly using the number buttons ("0" to "9") during playback mode, **PRE STOP** mode, etc.

Switching the Angle (DVD only)

On DVDs in which scenes have been filmed from multiple angles, the angle can be switched during playback.

1 During playback, **[7] (PAGE 1/3)**.

2 Press **[2] (ANGLE)**.

The angle switches between the angles recorded on the disc each time the button is pressed.

- Some time may be required for the angle to change.
- Depending on the disc, the angle may switch in one of two ways.
 - *Seamless:* The angle switches smoothly.
 - *Non-seamless:* When the angle is switched, a still picture is displayed first, after which the angle switches.

Switching the Audio Tracks

DVDs can have up to 8 different audio tracks. These alternate tracks can be switched during playback.

1 During playback, **[7] (PAGE 1/3)**.

2 Press **[1] (AUDIO)**.

The sound switches between the alternate audio tracks recorded on the disc each time the button is pressed.

- The alternate track selected becomes the default setting every time the power is turned on or the disc is replaced. If the disc does not include that track, the disc's default language is selected instead.
- Not all discs will allow changing the alternate audio tracks during playback. In these cases, select audio tracks from the DVDs menu.
- There may be a delay before the selected alternate track begins to play.

• Video CDs with multiplex audio

During playback, press **AUDIO on the supplied remote control.**

The left and right channels will be output as shown in the figure below, each time the button is pressed.

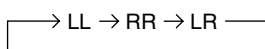

Switching the Subtitles (Subtitle Language) (DVD only)

With DVDs on which multiple subtitle languages are recorded, the subtitle language can be switched during playback; moreover, subtitles can be hidden.

1 During playback, press **[7]** (**PAGE 1/3**).

2 Press **[3]** (**SUB.T**).

The subtitle switches between the languages recorded on the disc each time the button is pressed; moreover, the subtitle is turned OFF.

- There may be a delay before the selected subtitle appears.
- Not all discs will allow changing the subtitles during playback. In these cases, select subtitles from the DVDs menu.
- The subtitle language selected becomes the default setting every time the power is turned on or the disc is replaced. If the disc does not include that language, the disc's default language is selected instead.
- For some discs, the subtitles will be displayed even when this is set to off.

Switching from the disc menu

For some discs, the audio language, angle and subtitles can be switched from the disc menu.

Operation from the remote control

- 1 Press **MENU** or press and hold **TITLE** (for at least 2 seconds), select the item, then press **ENTER**.
- 2 Use the **Joystick** to select the language or angle, then press **ENTER**.
(For some discs, they can be selected using the number buttons ("0" to "9") while the language or the angle menu is displayed.)

Operation from the main unit buttons I:

- 1 When DVD mode is selected, press **[5]** (**DVD MENU**).
The Function Guide is switched.
- 2 Press **[1]** (←), **[2]** (↑), **[3]** (↓), **[4]** (→) or **[5]** (**ENTER**) to set the item.

Operation from the main unit buttons II:

- 1 When DVD mode is selected, press **[7]** (**PAGE 1/3**).
The Function Guide is switched.
 - 2 Press the **[5]** (**TITLE MENU**).
 - 3 Press **[1]** (←), **[2]** (↑), **[3]** (↓), **[4]** (→) or **[5]** (**ENTER**) to set the item.
- By pressing **[6]** (**DVD RETURN**), the screen returns to the previous one.

Displaying the Disc Status for DVD

Use the procedure described below to display the status (title number, chapter number, etc.) of the currently playing DVD on the monitor screen.

1 During playback, press any one of the function buttons **[1]**~**[7]**.

The Function Guide is displayed.

2 Press and hold **[6]** (**GUIDE**) for more than 2 seconds.

The playback status is displayed.

The display returns to the previous one in 10 seconds.

Displaying the Disc Status for Video CD

Use the procedure described below to obtain an on-screen display of the status (track number, etc.) of the currently playing video CD.

1 During playback, press any one of the function buttons **[1]**~**[7]**.

The Function Guide is displayed.

2 Press and hold **[6]** (**GUIDE**) for more than 2 seconds.

The playback status is displayed.

The display returns to the previous one in 10 seconds.

Sound Setting

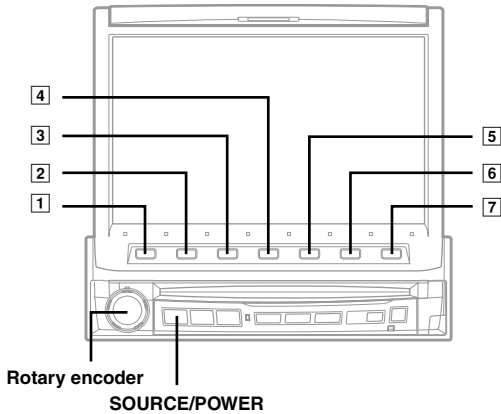

Setting the MX mode

To display the Audio processor mode screen:

To watch a video source, your vehicle must be parked with the ignition key in the ACC or ON position. To do this, follow the procedure below.

1. Bring your vehicle to a complete stop at a safe location. Engage the parking brake.
2. Keep pushing the foot brake and release the parking brake once then engage it again.
3. When the parking brake is engaged for the second time, release the foot brake.

- For automatic transmission vehicles, place the transmission lever in the Park position.

Now, the locking system for the Audio processor mode operation has been released. Engaging the parking brake can reactivate the Audio processor mode, as long as the car's ignition has not been turned off. It is not necessary to repeat the above procedure (1 through 3), of "To display the Audio processor mode screen." Each time the ignition is turned OFF, perform the procedure of "To display the Audio processor mode screen."

MX (Media Xpander) makes vocals or instruments sound distinct regardless of the music source. The radio, CD, and MP3, will be able to reproduce the music clearly even in cars with a lot of road noise.

1 Press SOURCE/POWER.

The main menu is displayed.

2 Press [4] (A.PROC).

A.PROC (Audio processor) list screen is displayed.

3 Turn the Rotary encoder to select "Media Xpander."

OFF: MX mode is canceled for all music sources.

ON: The selected MX mode is turned on.

4 After pressing [2] (ON), press [3] (SETUP).

MX list screen is displayed.

5 Turn the Rotary encoder to select your desired MX mode.

The screen shows the *Function Guide.

*Displays the function assigned for each button.

6 Press the Function button to switch the setting.

The level of the audio source can be adjusted. It is after switching the audio source that the MX mode is applied.

MX CD (OFF, CD1 to 3)

The large quantity of uncompressed CD data is processed to reproduce the sound with more clarity.

MX MP3 (OFF, MP3 1 to 3)/MX XM (OFF, XM1 to 3) /MX MD (OFF, MD1 to 3)

This corrects information that was omitted at the time of compression. This reproduces a well-balanced sound close to the original.

MX FM (OFF, FM1 to 3)

The medium to high frequencies become more clear, and produces well balanced sound in all the bands.

MX DVD (OFF, MOVIE 1 to 2)

The dialog portion of the video is reproduced more clearly.

(DVD MUSIC)

This disk contains a large quantity of data such as a music clip. MX uses this data to reproduce the sound accurately.

MX AUX 1 to 3 (OFF, MP3, MOVIE, MUSIC)

Choose the MX mode (MP3, MUSIC, or MOVIE) that corresponds to the media connected.

7 By pressing [7] (RETURN), return to the previous screen.

- When OFF is selected, MX effect of each MX mode will be off.
- Each music source, such as radio, CD and MP3 can have its own MX setting.
- XM, MD is displayed only when each product is connected.
- AUX is displayed when an external input device is connected and LEVEL LOW or LEVEL HIGH is selected in "Setting the AUX mode" (page 33).
- MX mode does not function for AM radio when MX is ON.
- If the unit is connected to an audio processor with the MX function, such as PXA-H700, etc., the MX processing can be applied to the audio processor. In this case the audio processor needs to be adjusted. For details, refer to the Owner's Manual of the audio processor.

Setting the Bass Engine

The following steps 1 to 7 are common operations to each "Setting item" of bass engine Setup. Refer to each section for details.

- 1 Press SOURCE/POWER.**
The main menu screen is displayed.
- 2 Press [4] (A.PROC).**
A.PROC (Audio processor) list screen is displayed.
- 3 Turn the Rotary encoder to select "bass engine."**
- 4 Press [1] (SETUP) .**
The bass engine list screen is displayed.
- 5 Turn the Rotary encoder to select your desired sound setting.**
The screen shows the *Function Guide.
*Displays the function assigned for each button.

Setting items
BASS ↔ TREBLE ↔ BASS FOCUS ↔ TIME CORRECTION ↔ CROSSOVER
- 6 Press the Function button to switch the setting.**
- 7 Press [7] (RETURN) .**
The screen returns to the previous one.

Setting the Bass Control

Setting item: BASS
Setting contents: FREQ.DN / UP / LEVEL DN / UP / WIDTH DN / UP

You can change the bass frequency emphasis to create your own tonal preference.

Setting the bass center frequency:

Press [1] (FREQ. ◀DN) or [2] (FREQ. UP▶) to select the desired bass center frequency.

60Hz ↔ 70Hz ↔ 80Hz ↔ 90Hz ↔
100Hz ↔ 130Hz ↔ 150Hz ↔ 180Hz

Emphasizes the displayed bass frequency ranges.

Setting the bass Level:

Press [3] (LEVEL ◀DN) or [4] (LEVEL UP▶) to select the desired bass Level (-7 - +7).

You can emphasize or weaken the bass frequency.

Setting the bass Band Width (Q-Factor):

Press [5] (WIDTH ◀DN) or [6] (WIDTH UP▶) button to select the desired bass Band Width.

Q 1 ↔ Q 2 ↔ Q 3 ↔ Q 4
(Narrow)←.....→(Wide)

Changes the bass boost band width to wide or narrow. A wide setting will boost a wide range of frequencies above and below the center frequency. A narrower setting will boost only frequencies near the center frequency.

- The settings of the bass level will be individually memorized for each source (FM, AM, XM, CD, etc.) until the setting is changed. Once you set Bass frequency and Bass Band Width for one of sources (FM, AM, XM, CD, etc.), this setting becomes effective for all those sources. Depending on the connected devices, some functions and display indications do not work.
- This function is inoperable when DEFEAT is ON.

Setting the Treble Control

Setting item: TREBLE
Setting contents: FREQ.DN / UP / LEVEL DN / UP

You can change the treble frequency emphasis to create your own tonal preference.

Setting the treble center frequency:

Press [1] (FREQ. ◀DN) or [2] (FREQ. UP▶) to select the desired treble center frequency.

10kHz ↔ 12.5kHz ↔ 15.0kHz ↔ 17.5kHz

Emphasizes the displayed treble frequency ranges.

Setting the treble level:

Press [3] (LEVEL ◀DN) or [4] (LEVEL UP▶) to select the desired treble level (-7 - +7).

You can emphasize the treble frequency.

- The settings of the treble level will be individually memorized for each source (FM, AM, XM, CD, etc.) until the setting is changed. Once you set the treble frequency for one of sources (FM, AM, XM, CD, etc.), this setting becomes effective for all those sources. Depending on the connected devices, some functions and display indications do not work.
- This function is inoperable when DEFEAT is ON.

About the Time Correction

The distance between the listener and the speakers in a car vary widely due to the special conditions of the mobile environment. This difference in the distances from the speakers to the listener creates a shift in the sounds image and frequency characteristics. This is caused by the time delay between the sound reaching the listener's right versus left ear.

To correct this, the IVA-D900 is able to delay the audio signal to the speakers closest to the listener. This effectively creates a perception of increased distance for those speakers. The listener can be placed at an equal distance between the left and right speakers for optimum staging.

The adjustment will be made for each speaker in a step of 0.1 ms.

Example 1. Listening Position: Front Left Seat

Adjust the time correction level of the front left speaker to a high value and the rear right to zero or a low value.

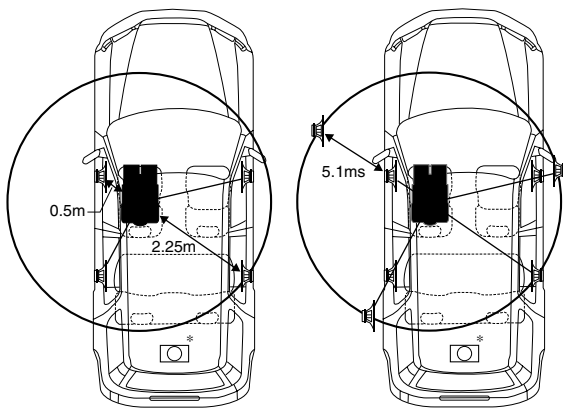

Tips

* Subwoofer speaker

You cannot change the time correction value for the subwoofer, but you can set the subwoofer's apparent position to the front by adjusting the time correction value of the front and rear speakers.

For details, refer to the "Tips" on page 23.

Here we calculate the time correction value for the front left speaker in the diagram above.

Conditions:

Farthest Speaker – listening position: 2.25 m (88-9/16")

Front left speaker – listening position: 0.5 m (19-11/16")

Calculation: $L = 2.25 \text{ m} - 0.5 \text{ m} = 1.75 \text{ m} (68-7/8")$

Time correction = $1.75 \div 343 * 1000 = 5.1 \text{ (ms)}$

* *Speed of sound: 343 m/s (765 mph) at 20°C*

The sound is not balanced because the distance between the listening position and the various speakers is different.

The difference in distance between the front left speaker and the rear right speaker is 1.75 m (68-7/8").

Time correction eliminates the differences in the time required for the sound to reach the listening position.

The time of the front left speaker is corrected by 5.1 ms so that its sound reaches the listening position at the same time as the sound of other speakers.

In other words, giving the front left speaker a time correction value of 5.1 ms makes it seem as if the distance to the front left speaker is the same as the distance to the farthest speaker.

Example 2. Listening Position: All Seats

Adjust the time correction level of each speaker to almost the same level.

1 Sit in the listening position (driver's seat, etc.) and measure the distance (in meters) between your head and the various speakers.

2 Calculate the difference between the distance to the farthest speaker and the other speakers.

$L = (\text{distance to farthest speaker}) - (\text{distance to other speakers})$

3 Divide the distances calculated for the speakers by the speed of sound (343 m/s (765 mph) at 20°C).

These values are the time correction values for the different speakers.

Bass Focus

Setting item: BASS FOCUS

Setting contents: TIME DN / UP / FRONT / LEFT / RIGHT / REAR

The time difference between the front-rear/left-right speakers, can be adjusted at the same time. With an initial delay of 0.1 ms for each of the 0 to 99 steps, audible time correction can be done.

Selecting the speaker:

Select the speaker among **3** (FRONT) through **6** (REAR).

Setting the step:

Press **1** (TIME ◀DN) or **2** (TIME ▶UP) to set the step.

- Any manual time correction adjustments will also affect corrections made for bass focus.

Time Difference Table

| Number of Steps | Time Difference (ms) | Number of Steps | Time Difference (ms) | Number of Steps | Time Difference (ms) |
|-----------------|----------------------|-----------------|----------------------|-----------------|----------------------|
| 0 | 0.0 | 14 | 1.4 | 28 | 2.8 |
| 1 | 0.1 | 15 | 1.5 | 29 | 2.9 |
| 2 | 0.2 | 16 | 1.6 | 30 | 3.0 |
| 3 | 0.3 | 17 | 1.7 | 31 | 3.1 |
| 4 | 0.4 | 18 | 1.8 | 32 | 3.2 |
| 5 | 0.5 | 19 | 1.9 | 33 | 3.3 |
| 6 | 0.6 | 20 | 2.0 | 34 | 3.4 |
| 7 | 0.7 | 21 | 2.1 | 35 | 3.5 |
| 8 | 0.8 | 22 | 2.2 | 36 | 3.6 |
| 9 | 0.9 | 23 | 2.3 | 37 | 3.7 |
| 10 | 1.0 | 24 | 2.4 | 38 | 3.8 |
| 11 | 1.1 | 25 | 2.5 | 39 | 3.9 |
| 12 | 1.2 | 26 | 2.6 | 40 - 98 | 4.0 - 9.8 |
| 13 | 1.3 | 27 | 2.7 | 99 | 9.9 |

Example of Bass Focus Setting

- 1 After entering corrections for the front (left and right) speakers in STEP 15, the time difference is 1.5 ms for both front-left and front-right speakers.

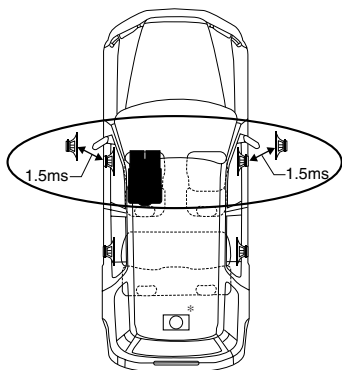

- 2 After entering corrections for the left (front and rear) speakers in STEP 15, the time difference becomes 3.0 ms* for the front left speaker and 1.5 ms for the left rear speaker.

* Because the time difference was already set to 1.5 ms for the front left speaker in STEP 1, the additional correction in STEP 15 makes the time difference of the front left speaker 3.0 ms.

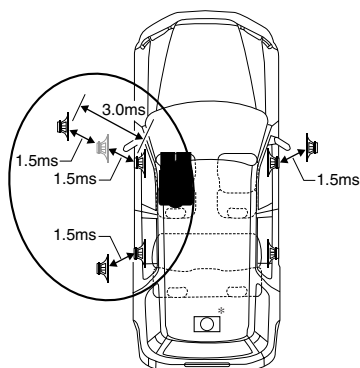

Tips

* Subwoofer speaker

Delay (turn the rotary encoder) the audio signal to the front (left and right) speakers to make the apparent position of the subwoofer to be at the front. In doing this, the apparent position between the front (left and right) speakers and subwoofer will appear equal to the driver. After performing above, you can change the positions of left and right speakers by delaying the time.

Time Correction

Setting item: TIME CORRECTION

Setting contents: TIME DN/UP/FRONT-LEFT/FRONT-RIGHT/REAR-LEFT/REAR-RIGHT

Before performing the following procedures, refer to "About the Time Correction" (page 22).

Selecting the speaker:

Select the speaker among [3] (FRONT-LEFT) through [6] (REAR-RIGHT).

Adjusting the time correction value:

Press [1] (TIME ◀DN) or [2] (TIME ▶UP) to adjust the time correction value (0.0 to 9.9).

Adjusting the Built-in Crossover

Setting item: CROSSOVER

Setting contents: LPF DN / UP / HPF DN / UP

The High and Low Pass Filters on this unit can be adjusted to suit your personal taste.

LPF (Setting the Low Pass Filter):

Press [1] (LPF ◀DN) or [2] (LPF ▶UP) to adjust LPF.

FLAT (OFF) ↔ 80Hz ↔ 120Hz ↔ 160Hz

Outputs all frequencies lower than that selected according to your preference.

(Only available when using the subwoofer output from this unit.)

- When the subwoofer output of this unit is turned OFF, LPF and phase are deactivated.

HPF (Setting the High Pass Filter):

Press [3] (HPF ◀DN) or [4] (HPF ▶UP) to adjust HPF.

FLAT (OFF) ↔ 80Hz ↔ 120Hz ↔ 160Hz

Outputs all frequencies higher than that selected according to your preference.

- If HPF, LPF, bass control and treble control are all set to ON, depending on the bass control and treble control settings, you may not be able to reinforce the sound effect.
- Except when the HPF and LPF is turned OFF, the subwoofer is in monaural mode.

Subwoofer On and Off

1 Press SOURCE/POWER.

The main menu is displayed.

2 Press [4] (A.PROC).

The A.PROC (Audio processor) list screen is displayed.

3 Turn the Rotary encoder to select "SUBWOOFER."

4 Press the Function button to select your desired setting.

OFF: Subwoofer output is off.

0°: Subwoofer output is on, and the phase is 0°.

180°: Subwoofer output is on, and the phase is 180°.

Other Useful Features

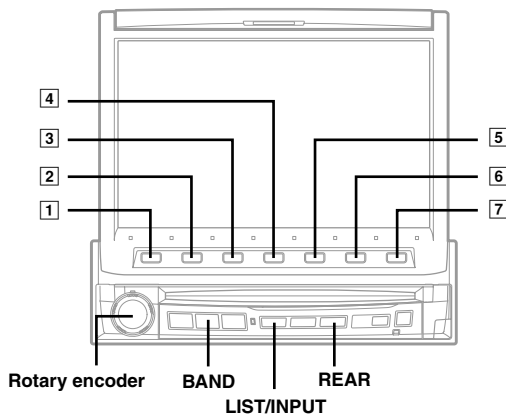

Titling Radio Stations/Discs

To display the Title Inputting screen:

To watch a video source, your vehicle must be parked with the ignition key in the ACC or ON position. To do this, follow the procedure below.

1. Bring your vehicle to a complete stop at a safe location. Engage the parking brake.
2. Keep pushing the foot brake and release the parking brake once then engage it again.
3. When the parking brake is engaged for the second time, release the foot brake.

- For automatic transmission vehicles, place the transmission lever in the Park position.

Now, the locking system for the Title Inputting mode operation has been released. Engaging the parking brake can reactivate the Title Inputting mode, as long as the car's ignition has not been turned off. It is not necessary to repeat the above procedure (1 through 3), of "To display the Title Inputting mode screen."

Each time the ignition is turned OFF, perform the procedure of "To display the Title Inputting mode screen."

- Trying to access this screen while driving will display the warning-CANT OPERATE WHILE DRIVING.

You can title radio stations and Discs (CD, Video CD). This manual describes how to title radio stations.

(You cannot title MP3 discs, except in an MP3 compatible CD changer.)

1 Activate the radio mode.

Tune in a radio station you wish to title.

2 Press and hold LIST/INPUT for at least 2 seconds.

The Title Inputting screen appears in the display and characters are displayed at the bottom menu.

3 Turn the Rotary encoder and select the desired character for the first position.

To change between upper case, lower case, numeral and symbol, press **[3] (A/1)**. Each press changes the bottom menu.

4 When the character for the first position has been selected, press the Rotary encoder.

The first character has been memorized at the first position. See "notes at the right" on this page.

5 Repeat steps 3 and 4 to enter the rest of characters.

You can input up to 16 characters for titling one radio station (or Disc).

6 When titling has been completed, press **[6] (WRITE)** to store the title in memory.

The display changes to the Radio mode.

To title other stations (or disc), repeat this procedure. You can title up to 100 (max.) stations and CDs combined. The input titles will be displayed when a station (or Disc) titled is selected.

- If the memory capacity for radio station titles is full and if you attempt to title a new station, the oldest title will be erased to make room for the new one. To delete a title, select the title you want to delete, then select "SPC" (space) and press **[6] (WRITE)**.
- When **[1] (◀ BACK)** or **[2] (NEXT ▶)** is pressed, the cursor moves to the left or right on the input titles.
- If an incorrect character has been entered, select "SPC" (space) and input a new character or press **[5] (DELETE)** to delete the previous character. Press **[4] (CLEAR)** while inputting the titles to erase all the characters you have input.
- Pressing **[7] (RETURN)** in the Title Input mode changes the display back to the previous display.
- When the memory is full, "FULL DATA" is displayed for 2 seconds. If the new title is input to the full memory, the title input at first is deleted and the newly input title is memorized.
- You can title the VIDEO CD/CD while it is in optional DVD player or DVD changer. The title you entered is displayed in the "Displaying the Title List" (pages 24 and 25). (Do not operate while driving. Stop the car, then use this operation.)
- Immediately after inputting titles or changing the settings of Setup mode or Display mode (while the system is inputting the titles or data automatically) do not turn the ignition key (engine key) to OFF. Otherwise, the title may not be written, or the settings may not be changed.

Displaying the Title List

The titled radio programs or discs can be displayed in the list. As for CD TEXT disc, the disc name, track name, etc., are displayed. During MP3 play, the folder names and file names are displayed. It is easy to tune in to the desired radio program or to play the desired disc.

(In Radio mode for example)

1 In the Radio mode, press LIST/INPUT.

The STATION TITLE LIST display appears.

2 Turn the Rotary encoder to move the cursor to your desired title.

3 Press the Rotary encoder.

The selected title starts to play, and the screen returns to the Radio mode.

To display the folder list or the file list of MP3 disc

- 1 Press **[6] (NEXT ▶)** while the disc title list is displayed. The folder title list of the selected disc is displayed.
 - 2 Turn the **Rotary encoder** to select the desired folder.
 - 3 Press **[6] (NEXT ▶)** to display the file (track) list of the selected folder.
To return to the previous screen, press **[5] (◀ BACK)**.
 - 4 Turn the **Rotary encoder** to select the desired file (track).
 - 5 Press the **Rotary encoder**. The selected title is played back.
- By pressing **[1] (DISC)**, Disc Title list display appears.
 - By pressing **[3] (XM)**, XM's Category list appears (only with an XM receiver connected).
 - If the disc is not titled, the display shows "NO TITLE." If no disc is loaded, the display shows "NO DISC."
 - Pressing **LIST/INPUT** or **[7] (RETURN)** while the disc title list is displayed, returns to the previous screen.
 - To directly go to the preset radio station list screen, press **[2] (RADIO)**. Then, press **BAND** to change the radio band.

Setting of Scrolling

When the discs are titled, the list of the titled can be scrolled. CD text, folder name, file name and ID3 tag also be able to be scrolled.

1 During play of the disc, press **[6] (SCROLL)** for more than 2 seconds.

AUTO scroll mode starts and the disc titles and the track titles are continuously scrolled one after the other.

2 By pressing **[6] (SCROLL)** for more than 2 seconds, AUTO scroll is canceled.

By pressing **[6] (SCROLL)** after AUTO scroll is canceled, disc titles and track titles are simultaneously scrolled once.

When a track reaches to its end, the list is scrolled once.

Description of "Title" and "Text":

Title: This unit allows you to title (name) Discs (page 24).

Text: Some CDs have pre-recorded text information for the CD/track names etc.

- Depending on the character styles, characters may not be displayed correctly.
- Text can only be displayed on CD changers that are enabled with CD TEXT.
- If both the disc and track titles are unavailable, the display will show "NO TITLE."

Rear Enter Function

The rear enter function independently routes different sources to the front and the rear inside a car. For example, while listening to the radio or other audio source in the front, DVD can be enjoyed in the rear with the optional rear monitor and headphones.

1 Press **SOURCE/POWER**.

The main menu is displayed.

2 Press **[3] (R.SEL)**.

Rear Select display appears.

- The **REAR** button also switches the screen to the Rear Select display.
- This function cannot be used when **MONITOR OUT 1** or **2** is set to **OFF** in the **SYSTEM SETUP**.

3 Press **[1] (REAR 1)** or **[2] (REAR 2)**.

When only one external monitor is connected, "REAR" is displayed.

REAR 1: The external monitor connected to AUX OUT1.

REAR 2: The external monitor connected to AUX OUT2.

4 Turn the Rotary encoder to select your desired source (the auxiliary input or built-in DVD).

- If this item is set to "INFO. DISP", the rear enter function will be off.
- When the "Setting the AUX Mode" (page 33) is set to **OFF**, the auxiliary source is not displayed.
- When **TV** is selected in **AUX IN 3 MODE**, **TV** is displayed.
- When **FRONT LINK** is selected, the same pictures with the front main source screen are output. The sound is not output.

5 Press the Rotary encoder.

The selected source for REAR 1 and REAR 2 is displayed respectively.

Switching the function of the remote sensor

For the remote control operation, the remote sensor of the external unit (monitor, etc.) can be switched as you prefer.

6 Press **REAR** for more than 2 seconds.

It enters to the monitor switching mode in which the prior remote control can be selected.

7 Press **REAR**.

Each time it is pressed, the external monitor which has a priority to the remote control operation is changed. The icon indicator (REAR 1 or REAR 2)* of the selected monitor is displayed.

REAR1: The remote sensor of the external monitor connected to AUX OUT1 is effective, and the remote control can operate only the source selected for the terminals.

REAR2: The remote sensor of the external monitor connected to AUX OUT2 is effective, and the remote control can operate only the source selected for the terminals.

* When only one external monitor is connected and the output is set to **ON**, the **REAR** icon indicator is displayed. (See "Setting of the External Monitor Output," page 34.)

The monitor switching mode is canceled by pressing **REAR** for more than 2 seconds.

- When the remote sensor on the external monitor is effective, pressing sound (beep sound) does not come out.
- When there is an external interruption, the external interruption icon is prior to the others.
- When you watch the built-in DVD in **IVA-D900** (front monitor) and in the rear monitor, the On Screen display of the rear monitor (**PLAY**, **PAUSE**, **FAST FWD**, etc.) is not displayed.

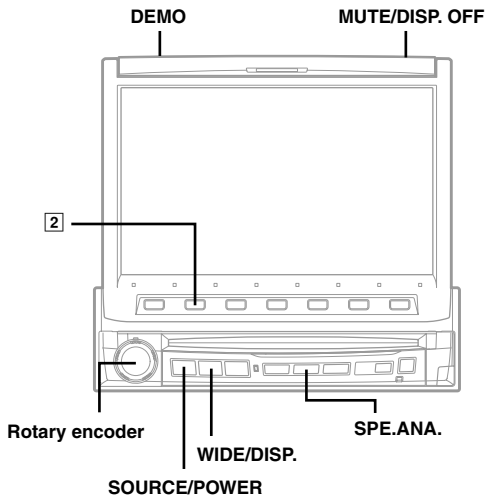

Blackout Mode On and Off

When Blackout mode is turned on, the display will turn off to reduce power consumption.

This additional power enhances the sound quality.

Press and hold MUTE/DISP. OFF for at least 2 seconds to start the blackout mode.

By doing so the display will turn off.

- *If any button on the unit is pressed during Blackout mode, the function will be displayed for 5 seconds to show the operation before returning to Blackout mode.*

To cancel Blackout mode, press and hold **MUTE/DISP. OFF** for at least 2 seconds.

Demonstration

This unit has a Demonstration feature which simulates the display functions.

- 1 Press and hold DEMO for at least 2 seconds.**
Each press toggle between DEMO ON and DEMO OFF.
- 2 Press and hold DEMO for at least 2 seconds to return to normal operation.**

Switching Display Modes

After carrying out the steps 1 to 3 of "To display the DVD mode Screen" explained on page 28, perform the operation described below.

Press and hold WIDE/DISP for at least 2 seconds in the visual source.

Each press changes the display modes as follows:

MODE 1 → MODE 2 → MODE 3 → MODE 1
(WIDE) (NORMAL) (CINEMA) (WIDE)

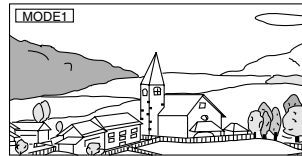

In Mode 1 (Wide), the monitor displays a normal picture wider to fit in a wide-screen monitor by evenly stretching out the picture horizontally.

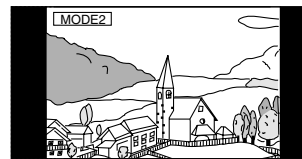

In Mode 2 (Normal), the monitor displays a normal picture at the center of the screen with a vertical black band at each side.

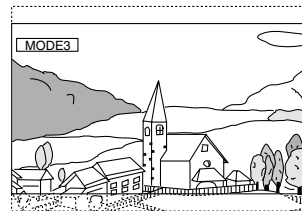

In Mode 3 (Cinema), the monitor displays a normal picture by stretching out the picture horizontally and vertically. This mode is good for displaying a cinema type picture at the 16:9 ratio.

Displaying the Spectrum Analyzer

Depending on the external audio processor connected to the unit, this function may not work properly.

- 1 When one of the sources except for the video source is selected, press **SPE.ANA.** to turn on the spectrum analyzer mode.
- 2 Each time you press **SPE.ANA.**, the spectrum analyzer modes change.

SCAN → MODE 1 → MODE 2 → MODE 3 → SCAN

There are three modes, select your desired mode to match the music being played.

Mode 1:

This mode emphasizes the rhythmical bass sound and gives an image of vivid low frequencies.



Mode 2:

This mode is suitable to vocal song music.



Mode 3:

This mode can be used for any genre of music.

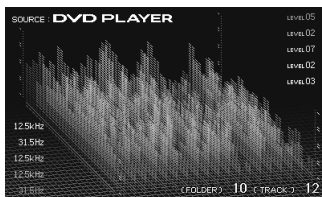

SCAN Display

It displays mode1 to mode 3 repeatedly.

- 3 To deactivate the spectrum analyzer mode, press **SPE.ANA.** for at least 2 seconds.

Switching the Visual Source Only (Simul Function)

You can watch the video portion of another source while listening to the current source.

- After carrying out the steps 1 to 3 of "To display the DVD mode Screen" explained on page 28, perform the operation described below.

- 1 Press **SOURCE/POWER.**
The main menu appears on the display.
- 2 Press **[2] (V.SEL)** to select the video portion.
- 3 Turn the **Rotary encoder** and select your desired video source.

When "INFO.DISP" is selected, the main display shows playing disc (DVD, Video CD) status or auxiliary input (AUX, TV, etc.) status.

If the spectrum analyzer has been set in "Displaying Spectrum Analyzer (page 27)", the spectrum analyzer mode display appears here.

(Example)

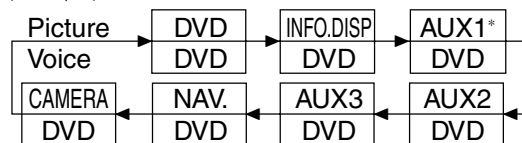

- * If a DVD player is connected, you can receive the DVD picture/sound.

DVD player (DVA-5205) or DVD changer (DHA-S680) is connected:

Press and hold **V.OUT** on the remote control supplied with the DVD player or DVD changer for more than 2 seconds. The picture and sound of the DVD will be output.

- The Simul function cannot be used when the Audio source is in the navigation mode.
- By pressing **V.SEL** for more than 2 seconds, the Simul function is canceled. (Even if **[2] (V.SEL)** of the function button is pressed for more than 2 seconds, it is not canceled.)

- 4 Press the **Rotary encoder** to execute the selection.

Setup

DVD Setup

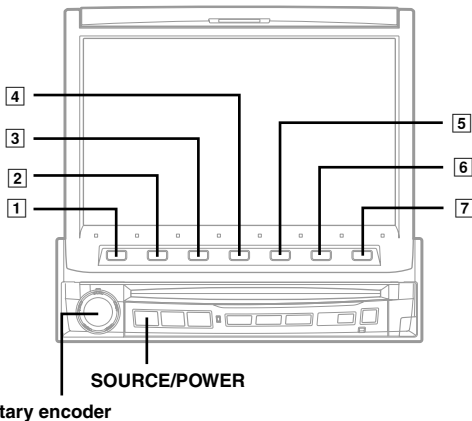

4 Turn the **Rotary encoder** to select your desired setting item.

The screen shows the *Function Guide.

* Displays the function assigned for each button (the Function buttons).

Setting items:

MENU LANGUAGE ↔ AUDIO LANGUAGE ↔
SUB T. LANGUAGE ↔ COUNTRY CODE ↔ PARENTAL ↔
DIGITAL OUT MODE ↔ OPT. OUT ↔ TV SCREEN

5 Press the **Function buttons** to switch the setting.

6 Press **[7] (RETURN)**.

The screen returns to the previous one.

- With the DVD screen displayed, pressing and rotating the rotary encoder will adjust the volume level.
- Immediately after inputting titles or changing the settings of DVD mode (while the system is inputting the titles or data automatically) do not turn the ignition key (engine key) to OFF. Otherwise, a title may not be written, or the settings may not be changed.

Changing the language setting

The audio language, subtitle language and menu language can be set according to your preferences.

Once set, this becomes the default language. This function is convenient when you always want to listen in English. (The language setting is not effective on some discs. If not, the default language is set from the factory.)

- When the settings are changed, the old settings are overwritten. Make a note of the current settings before making changes. The settings are not cleared even when the vehicle's battery is disconnected.
- To temporarily change the language of the current disc, either do so from the DVD menu or by using the operation described in the section "Switching the audio tracks" (page 18).
- If the disc does not include the selected language, the disc's default language is set.

DVD Setup Operation

To display the DVD mode screen:

To watch a video source, your vehicle must be parked with the ignition key in the ACC or ON position. To do this, follow the procedure below.

1. Bring your vehicle to a complete stop at a safe location. Engage the parking brake.
2. Keep pushing the foot brake and release the parking brake once then engage it again.
3. When the parking brake is engaged for the second time, release the foot brake.

- For automatic transmission vehicles, place the transmission lever in the Park position.

Now, the locking system for the DVD mode operation has been released. Engaging the parking brake can reactivate the DVD mode, as long as the car's ignition has not been turned off. It is not necessary to repeat the above procedure (1 through 3), of "To display the DVD mode screen."

Each time the ignition is turned OFF, perform the procedure of "To display the DVD mode screen."

Before setup operation below, select the DVD PLAYER mode.

If a disc is inserted into this unit, make sure to take it out.

The following steps 1 to 6 are common operations to each "Setting item" of DVD Setup. Refer to each section for details.

1 Press **SOURCE/POWER**.

The main menu is displayed.

2 Press **[6] (SETUP)**.

The Setup mode screen appears.

3 Turn the **Rotary encoder** to select "DVD," then press the **Rotary encoder**.

The DVD list is displayed.

Setting of the Menu Language

Setting item: MENU LANGUAGE

Setting contents: AUTO / ENGLISH / GERMAN/FRENCH / JAPAN / CODE

Set the language used for the menus (title menu, etc.).

- When "AUTO" is selected, the primary menu language among the recorded ones is played.

Setting of the Audio Language

Setting item: AUDIO LANGUAGE

Setting contents: AUTO/ ENGLISH / GERMAN / FRENCH / JAPAN / CODE

Set the audio language produced from the speakers.

- When "AUTO" is selected, the primary audio language among the recorded ones is played.

Setting of the Subtitle Language

Setting item: SUB T. LANGUAGE

Setting contents: AUTO / ENGLISH / GERMAN / FRENCH / JAPAN / CODE

Set the language of the subtitles displayed on the screen.

- When "AUTO" is selected, the primary subtitle language among the recorded ones is played.

To play in a language other than those displayed

- 1 Press **[6] (CODE)** of the Function buttons. Number input box is displayed.
- 2 Turn the **Rotary encoder** to input the first digit of the language number. As for the language number, refer to "List of language code" (page 59).
- 3 Press the **Rotary encoder** to enter the first digit number.
- 4 Repeat steps 2 and 3 to input a 4 digit language number, then press **[6] (ENTER)** to memorize the number.

Changing the Country Code Setting

Setting item: COUNTRY CODE

Setting content: CODE

Set the country code when setting the rating level (Parental lock).

- When the settings are changed, the old settings are overwritten. Make a note of the current settings before making changes. The settings are not cleared even when the vehicle's battery is disconnected.

- 1 Press **[6] (CODE)**. Number input box is displayed.
- 2 Turn the **Rotary encoder** to input the first digit of the country number. As for the country number, refer to "List of Country Codes" (page 60).
- 3 Press the **Rotary encoder** to enter the first digit.
- 4 Repeat steps 2 and 3 to input a 4 digit country code, then press **[6] (ENTER)** to memorize the code.

Setting the Rating Level (Parental Lock)

Setting item: PARENTAL

Setting content: P-WORD

Use this function to restrict the viewing of movies to children of appropriate age levels only.

- When the settings are changed, the old settings are overwritten. Make a note of the current settings before making changes. Then settings are not cleared even when the vehicle's battery is disconnected.
- On unrated DVDs, playback will not be restricted even if the rating level is set.
- Once set, this rating level remains in memory until changed. To enable playback of discs of higher rating levels or to cancel the parental lock, the setting must be changed.
- Not all DVDs provide a Parental Lock feature. If you are unsure about a DVD, play it first to confirm. Do not leave DVDs accessible to young children for whom you deem them inappropriate.

- 1 Press **[1] (P-WORD)**. Number input box is displayed.
- 2 Press **0** to **9** on the supplied remote control to input the password. The initial number is 1111. Input a 4 digit pass word. Input numbers are displayed as "*".
- 3 Press **[1] (ENTER)** to memorize the number. The PARENTAL screen appears.

Set the rating level of PARENTAL

- 4 Turn the **Rotary encoder** to select PARENTAL LEVEL.
- 5 Press **[1] (◀DN)** or **[2] (UP▶)** to select the rating level (1 to 8). Select "8" to cancel the parental lock or if you do not want to set a rating level. The smaller the number, the higher the rating level.
- 6 Press **[7] (RETURN)** to return to the previous screen.

Changing the password

- 4 Turn the **Rotary encoder** to select PASSWORD CHANGE.
- 5 Press **[1] (P-WORD)**.
- 6 Turn the **Rotary encoder** to input numbers, then press the **Rotary encoder** to enter a new 4 digit pass word.
 - Keep a note of the number somewhere safe in case you should forget it.
- 7 Press **[1] (ENTER)** to memorize the number.
- 8 Press **[7] (RETURN)** to return the previous screen.

Changing the rating level temporarily

Some discs may request that you change the rating level set in the default settings during playback. In this case, the message appears on the monitor screen "PARENTAL LEVEL CHANGE OK? <YES/NO>."

If this screen appears, change the level as follows:

- To change parental level and play, press **[2] (▶/■)**.
- To play without changing the parental level, press **[4] (■)**. (When **[4] (■)** is pressed, playback will be at the parental level set with "Setting Parental Lock.")

Continued

Changing the Digital Output Setting

Use the following procedure to set the digital audio signal output from the IVA-D900.

Setting item: DIGITAL OUT MODE

Setting contents: AUTO / LPCM

AUTO: The digital output is switched automatically according to the type of audio signals being played.
Be sure to select "AUTO" when you want to connect a digital audio processor and play Dolby Digital audio.
"AUTO" is the factory setting.

LPCM: The audio signals recorded on the disc are converted to 48 kHz/16 bit (for DVDs) or 44.1 kHz (for video CDs and CDs) linear PCM audio signals for output.

Audio output/Optical digital audio output

| Disc | Audio recording format | | Digital output setting | Optical digital audio output (when a digital audio processor is connected) | Analog audio output (Ai-NET, RCA output) |
|----------|--|---------------|------------------------|--|--|
| DVD | DTS | | AUTO | DTS Elementary Stream | OK |
| | | | LPCM | LPCM Encode 2ch Down mix (48kHz/16bit) | OK |
| | Dolby Digital | | AUTO | Dolby Digital | OK |
| | | | LPCM | LPCM (48kHz/16bit) | OK |
| | Linear PCM | 48kHz/16bit | AUTO or LPCM | LPCM (48kHz/16bit) | OK |
| | | 48kHz/20bit | AUTO or LPCM | LPCM (48kHz/16bit) | OK |
| | | 48kHz/24bit | AUTO or LPCM | LPCM (48kHz/16bit) | OK |
| | | 96kHz/16bit | AUTO or LPCM | LPCM (48kHz/16bit) | OK |
| | | 96kHz/20bit | AUTO or LPCM | LPCM (48kHz/16bit) | OK |
| | | 96kHz/24bit | AUTO or LPCM | LPCM (48kHz/16bit) | OK |
| | MPEG2 | | AUTO or LPCM | LPCM (48kHz/16bit) | OK |
| Video CD | MPEG1 | | AUTO or LPCM | LPCM (44.1kHz) | OK |
| CD | Linear PCM | | AUTO or LPCM | LPCM (44.1kHz) | OK |
| | DTS | | AUTO | DTS Elementary Stream | OK |
| | | | LPCM | LPCM Encode 2ch Down mix (44.1kHz/16bit) | OK |
| MP3 | MPEG Audio Layer3 Bit Rate: 32kbps~ 320kbps | 32kHz/16bit | AUTO or LPCM | LPCM Encode 2ch (32kHz/16bit) | OK |
| | | 44.1kHz/16bit | AUTO or LPCM | LPCM Encode 2ch (44.1kHz/16bit) | OK |
| | | 48kHz/16bit | AUTO or LPCM | LPCM Encode 2ch (48kHz/16bit) | OK |

Setting the Digital Output

To connect an audio processor using the optical digital output, set to "ON" by the following procedure.

Setting item: OPT.OUT

Setting contents: OFF / ON

- Afterwards, set ACC to OFF once, then turn it ON again. The setting of Digital Output is decided.

Setting the TV Screen Setting

Use the procedure described below to set the output screen according to the type of TV monitor (rear monitor) being used.

Setting item: TV SCREEN

Setting contents: 4:3 LB / 4:3 PS / 16:9

- For some discs, the picture may not be set to the selected screen size. (For details, refer to the explanation on the disc's jacket.)

4:3 LB:

Select this when connected to a conventional 4:3 size (normal TV aspect ratio) monitor. There may be black stripes visible at the top and bottom of the screen (when playing a 16 : 9 size movie). The width of these stripes will depend upon the original aspect ratio of the theatrical release of the movie.



4:3 PS:

Select this when connected to a conventional 4:3 size monitor. The picture will fill the entire TV screen. However, due to the mismatch in aspect ratio, parts of the movie at the extreme left and right sides will not be visible (when playing a 16 : 9 size movie).



16:9:

Select this when connected to a wide screen TV. This is the factory setting.



GENERAL Setup

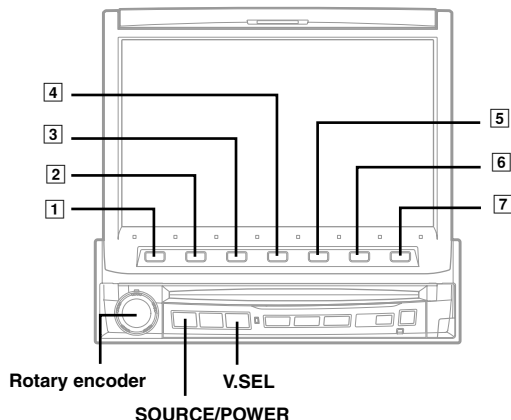

General Setup Operation

To display the General mode screen:

To watch a video source, your vehicle must be parked with the ignition key in the ACC or ON position. To do this, follow the procedure below.

1. Bring your vehicle to a complete stop at a safe location. Engage the parking brake.
2. Keep pushing the foot brake and release the parking brake once then engage it again.
3. When the parking brake is engaged for the second time, release the foot brake.

- For automatic transmission vehicles, place the transmission lever in the Park position.

Now, the locking system for the General mode operation has been released. Engaging the parking brake can reactivate the General mode, as long as the car's ignition has not been turned off. It is not necessary to repeat the above procedure (1 through 3), of "To display the General mode screen."

Each time the ignition is turned OFF, perform the procedure of "To display the General mode screen."

The following steps 1 to 6 are common operations to each "Setting item" of GENERAL Setup. Refer to each section for details.

- 1 Press SOURCE/POWER.**
The main menu is displayed.
- 2 Press [6] (SETUP).**
The Setup mode screen appears.
- 3 Turn the Rotary encoder to select "GENERAL," then press the Rotary encoder.**
The GENERAL list is displayed.

Continued

4 Turn the **Rotary encoder** to select your desired setting item.

The screen shows the *Function Guide.

* Displays the function assigned for each button (the Function buttons).

Setting items:

MONITOR OPEN/CLOSE ↔ V.SEL KEY ↔ MULTI SESSION PLAY ↔ BEEP ↔ CLOCK ↔ CLOCK ADJUST ↔ DAYLIGHT SAVING TIME ↔ *PHONE RECEIVE

* Displayed only when Mobile Hub (CXA-B200NK) is connected.

5 Press the **Function buttons** to switch the setting.

6 Press [7] (**RETURN**).

The screen returns to the previous one.

- With the General screen displayed, pressing and rotating the rotary encoder can adjust the volume level.
- Immediately after inputting titles or changing the settings of General Mode (While the system is inputting the titles or data automatically) do not turn the ignition key (engine key) to OFF. Otherwise, the title may not be written, or the settings may not be changed.

Setting Automatic Opening/Closing of the Monitor

Setting item: **MONITOR OPEN / CLOSE**

Setting content: **MANUAL / FULL / CLOSE**

MANUAL: The monitor is manually opened or closed by pressing **OPEN/CLOSE**.

FULL: The monitor automatically opens when the ignition key is turned to the "ACC" or "ON" position.

CLOSE: The monitor automatically closes when the ignition key is turned OFF.

Setting Visual Mode

Setting item: **V.SEL KEY**

Setting content: **NAV. / V.SEL**

You can display the screen of the preset item by just pressing the V.SEL button on the IVA-D900.

NAV.: Pressing **V.SEL** directly switches to the navigation screen.

V.SEL: Each press of **V.SEL** switches the modes:

<ex.>

SOURCE DISPLAY → AUX1 → AUX2 → AUX3

→ Navigation → CAMERA → SOURCE DISPLAY

- This operation cannot be carried out when NAV. IN, CAMERA IN and AUX IN 1 to 3 in the SYSTEM list screen are set to off.

Playing MP3 Data

Setting item: **MULTI SESSION PLAY**

Setting content: **CD / MP3**

When using discs containing both audio data and MP3 data.

CD: Plays only the audio data on discs containing both audio data and MP3 data.

MP3: Plays only the MP3 files on discs containing both audio data and MP3 data.

- When an MP3 CD changer is used, both the audio data and the MP3 data will be played.

Sound (Beep) Guide Function

Setting item: **BEEP**

Setting content: **OFF / ON**

ON: Activate the Sound Guide mode.

OFF: Deactivate the Sound Guide mode. The sound guide beep will not be produced when a button on the unit is pressed.

Displaying the Time

Setting item: **CLOCK**

Setting content: **OFF / ON**

The clock display is turned off or on respectively.

Setting the Time

Setting item: **CLOCK ADJUST**

Setting content: **HOURL DN / UP / MINUTE DN / UP / TIME RESET**

HOURL DN / UP: Adjust the hour.

MINUTE DN / UP: Adjust the minute.

TIME RESET: When it is pressed at "less than 30," the minute will be ":00"; at "more than 30," the hour advances.

- The clock adjusting mode is canceled when the power is turned off, when [7] (**RETURN**) is pressed, or when another item of **GENERAL SETUP** is selected.

Setting Daylight Saving Time

Setting item: **DAYLIGHT SAVING TIME**

Setting content: **OFF / ON**

ON: Place the Summer Time mode ON. The time advances by one hour.

OFF: Return to the ordinary time.

Switching the Incoming Calls of the Telephone

Setting item: **PHONE RECEIVE**

Setting content: **AUTO / MANUAL**

This operation can be carried out only when a cellular phone and Mobile Hub (CXA-B200NK) is connected.

- The incoming call can be switched to Automatic Calling or Manual Calling.

SYSTEM Setup

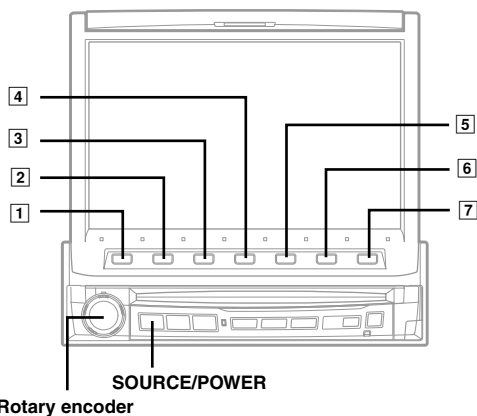

System Setup Operation

To display the System mode screen:

To watch a video source, your vehicle must be parked with the ignition key in the ACC or ON position. To do this, follow the procedure below.

1. Brake to bring your vehicle to a complete stop at a safe location. Engage the parking brake.
2. Keep pushing the foot brake and release the parking brake once then engage it again.
3. When the parking brake is engaged for the second time, release the foot brake.

- For automatic transmission vehicles, place the transmission lever in the Park position.

Now, the locking system for the System mode operation has been released. Engaging the parking brake can reactivate the System mode, as long as the car's ignition has not been turned off. It is not necessary to repeat the above procedure (1 through 3), of "To display the System mode screen."

Each time the ignition is turned OFF, perform the procedure of "To display the System mode screen."

The following steps 1 to 6 are common operations to each "Setting item" of SYSTEM Setup. Refer to each section for details.

1 Press SOURCE/POWER.

The main menu is displayed.

2 Press [6] (SETUP).

The Setup mode screen appears.

3 Turn the Rotary encoder to select "SYSTEM," then press the Rotary encoder.

The SYSTEM list is displayed.

4 Turn the Rotary encoder to select your desired setting item.

The screen shows the *Function Guide.

* Displays the function assigned for each button (the Function buttons).

Setting items:

NAV.MIX ↔ NAV.IN ↔ AUX IN1 ↔ AUX IN2 ↔ AUX IN3
↔ AUX IN1 MODE ↔ AUX IN2 MODE ↔ AUX IN3 MODE
↔ CAMERA IN ↔ MONITOR OUT1 ↔ MONITOR OUT2
↔ IN-INT MUTE ↔ IN-INT ICON ↔ A.PROC TYPE

5 Press the function buttons to switch the setting.

6 Press [7] (RETURN).

The screen returns to the previous one.

- With the System screen displayed, pressing and rotating the rotary encoder will adjust the volume level.
- Immediately after inputting titles or changing the settings of System Mode (While the system is inputting the titles or data automatically) do not turn the ignition key (engine key) to OFF. Otherwise, a title may not be written, or the settings may not be changed.

Navigation Interruption and Adjusting its Volume

Setting item: NAV.MIX

Setting content: OFF / ON

With an Alpine navigation system connected to the IVA-D900, the voice guidance of the navigation system will be mixed with the radio or CD play. You can adjust the volume level of the voice guidance.

OFF: The navigation interruption mode is turned off.

ON: The navigation interruption mode is on.

- 1) After setting it to ON, press the **Rotary encoder** to select NAV.MIX mode.
VOL. → NAV. → SUB W. → BAL. → FAD. → DEFEAT → VOL.
- 2) Turn the **Rotary encoder** to adjust the volume (0 to 15) of the navigation voice.
 - The audio volume during the navigation guide can be set by adjusting the audio volume while the navigation guide continues. When the navigation guide finishes, the previous audio volume and the previous screen are restored. For exception, if the navigation cuts in when the audio volume is lower than the setting level, the audio volume during the navigation guide is reset the current listening volume. (When the navigation guide cuts in, the audio volume does not increase.)
 - This setting is effective when NAV.IN of SYSTEM list screen is ON.
 - When PXA-H510 or PXA-H900 is connected, NAV.MIX value set in this unit does not affect PXA-H510 or PXA-H900.

Setting the Navigation Mode

When you connect an optional navigation equipment, set it to ON.

Setting item: NAV. IN

Setting contents: OFF / ON

ON: Navigation source is displayed.

OFF: Navigation source is not displayed. The settings related to the navigation can not be changed from this unit.

Setting the AUX Mode

Setting item: AUX IN 1, 2, 3

Setting content: OFF / LEVEL LOW / HIGH

OFF: AUX source is not displayed.

LEVEL LOW/HIGH:

The sound volume from the external equipment can be adjusted. When LOW or HIGH is selected, AUX source will be ON.

- OFF is not displayed when the optional DVD player or DVD changer is connected.
- When OFF is selected, the settings related to AUX can not be changed from this unit (except for "Name external equipment to be displayed" page 34).
- When either DVD player or DVD changer is connected to AUX IN 1, DVD is displayed on the screen. When both of them are connected, DVD is displayed for AUX IN 1 and DVD CHG is displayed for AUX IN 2.

Continued

Name External Equipment to be Displayed

When more than one external device is connected, you can name each (up to 3) as you like.

Setting items: AUX IN 1 to 3 MODE

Setting contents: AUX / VCR / GAME 1,2 / TV

- The selected source name is displayed instead of AUX source name. When a source is selected, the Function Guide of AUX mode appears.
- Only AUX IN 3 MODE can be named "TV." When AUX mode is selected, "TV" is displayed as the source name and the Function Guide of TV mode appears.
- Only when an Alpine TV tuner is connected, can you operate the displayed function guide from this unit.

Setting of the Rear Camera

When the rear camera is connected, rear pictures are output on the screen.

Setting item: CAMERA IN

Setting contents: OFF/ON

- ON:** Even if the shift lever is not set to reverse (R), the rear pictures are output by pressing **V.SEL** and selecting the CAMERA source.
- OFF:** The rear pictures are not output.
- By shifting to reverse (R), the rear pictures are output. This function is effective when the reverse wire is properly connected.

Setting of the External Monitor Output

Set it to ON when you use the rear enter function (page 25).

Setting items: MONITOR OUT 1, 2

Setting contents: OFF / ON

- ON:** By setting the connected external monitor to ON, the remote control will be usable.
- OFF:** When either MONITOR OUT 1 or 2 is set to OFF, only one monitor can be set by the rear enter function. When both MONITOR OUT 1 and 2 are set to OFF, R.SEL in the Function Guide displayed in the main menu cannot be used.

Setting the External Device Interrupt Mode

Setting item: IN-INT MUTE

Setting content: OFF / ON

If an Alpine Ai-NET Auxiliary Input Adapter (KCA-801B) is connected to the IVA-D900, an Auxiliary Source will be allowed to interrupt the current audio source. For example, you can listen to a portable MP3 player through your car audio system even with a CD changer connected and playing. The CD changer will automatically mute when switched to the AUX Input. For further details on how to use the Alpine KCA-801B, see your authorized Alpine dealer.

- OFF:** The volume level can be adjusted in Interrupt mode.
- ON:** Sound will not be output.
- The auxiliary device being connected must have an Interrupt wire with a positive trigger for this function to operate automatically. Otherwise, a separate switch needs to be added to switch it manually.

Setting the Interrupt Icon Display

Setting item: IN-INT ICON

Setting content: INT / TEL

The unit can display the icon of an external device, such as a telephone, whenever a phone call comes in to tell you there is a phone call.

INT: The INT icon appears on the display.

TEL: When the external device (telephone) sends the interrupt signal, the telephone icon appears on the display.

- TEL icon on this setting is not related to TEL Link Operation (pages 40 - 43).

Optical Digital Input Selection for an External Audio Processor

Make sure "OPT.OUT" is ON in "Setting the Digital Output" (page 31) before switching this setting.

Setting item: A.PROC TYPE

Setting contents: PXA-H510 / OTHER

OTHER:

When connecting any audio processor via an optical digital cable except the PXA-H510.

Connect the optical digital input connector with the connector for the Head unit.

PXA-H510:

When connecting PXA-H510.

Connect the optical digital input connector with the connector for the DVD.

- Afterwards, set ACC to OFF once, then turn it ON again. The setting of optical digital input switch is decided.

DISPLAY Setup

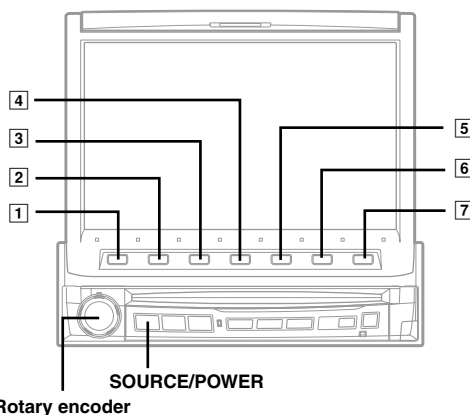

Display Setup Operation

To display the Display mode screen:

To watch a video source, your vehicle must be parked with the ignition key in the ACC or ON position. To do this, follow the procedure below.

1. Bring your vehicle to a complete stop at a safe location. Engage the parking brake.
2. Keep pushing the foot brake and release the parking brake once then engage it again.
3. When the parking brake is engaged for the second time, release the foot brake.

- For automatic transmission vehicles, place the transmission lever in the Park position.

Now, the locking system for the Display mode operation has been released. Engaging the parking brake can reactivate the Display mode, as long as the car's ignition has not been turned off. It is not necessary to repeat the above procedure (1 through 3), of "To display the Display mode screen." Each time the ignition is turned OFF, perform the procedure of "To display the Display mode screen."

The following steps 1 to 6 are common operations to each "Setting item" of DISPLAY Setup. Refer to each section for details.

1 Press SOURCE/POWER.

The main menu is displayed.

2 Press [6] (SETUP).

The Setup mode screen appears.

3 Turn the Rotary encoder to select "DISPLAY," then press the Rotary encoder.

The DISPLAY list is displayed.

4 Turn the Rotary encoder to select your desired setting item.

The screen shows the *Function Guide.

* Displays the function assigned for each button (the Function buttons).

Setting items:

DIMMER ↔ BRIGHT ↔ TINT ↔ COLOR ↔ BACK GND
↔ AUTO BACK GND

5 Press the function buttons to switch the setting.

6 Press [7] (RETURN).

The screen returns to the previous one.

- With the Display screen displayed, pressing and rotating the rotary encoder can adjust the volume level.
- Immediately after inputting titles or changing the settings of Display Mode (While the system is inputting the titles or data automatically) do not turn the ignition key (engine key) to OFF. Otherwise, a title may not be written, or the settings may not be changed.

Illumination Control

Setting item: DIMMER

Setting content: OFF / ON / AUTO

The back light (fluorescent light) built in the liquid crystal panel is switched to the brightness of the car inside to be easy to be seen.

- OFF:** Deactivate Auto Dimmer mode to keep the background illumination of the monitor bright.
- ON:** Keep the background illumination of the monitor dark.

AUTO: Adjust the brightness of the background illumination of the monitor automatically to the brightness of the car inside.

Adjusting Brightness

Setting item: BRIGHT

Setting content: DARK / ±0 / LIGHT

DARK / LIGHT:

Press [1] (◀ DARK) to make the picture darker or press [3] (LIGHT ▶) to make the picture brighter. You can adjust the brightness between MIN (-15) and MAX (+15). When it reaches the minimum or maximum point, the display shows "MIN" or "MAX" respectively.

±0: To quickly set to the center position, press [2] (±0).

Adjusting Tint of Picture

Setting item: TINT

Setting content: GRN. / ±0 / RED

Tint adjustment can be made only in the navigation, DVD, AUX1, AUX2 and AUX3 modes.

Tint adjustment cannot be made if a Navigation system with the RGB feature is connected.

GRN / RED: Press [1] (◀ GRN) to adjust green and press [3] (RED ▶) to adjust red.

Adjust the color from G15 to R15. "G MAX" or "R MAX" is displayed at the maximum of each color.

±0: To quickly set to the center position, press [2] (±0).

Adjusting Color of Picture

Setting item: COLOR

Setting content: THIN / ±0 / THICK

Color adjustment can be made only in the navigation, DVD, AUX1, AUX2 and AUX3 modes.

Color adjustment cannot be made if a Navigation system with the RGB feature is connected.

THIN / THICK:

Press [1] (◀ THIN) or [3] (THICK ▶) to make the color of the picture brighter or darker respectively to get your desired color. You can adjust the color between MIN (-15) and MAX (+15). When it reaches the minimum or maximum point, the display shows "MIN" or "MAX" respectively.

±0: To quickly set to the center position, press [2] (±0).

Switching Background Textures

Setting item: BACK GND

Setting content: MODE1(WATER) / MODE2(WOOD) / MODE3(SKY) / MODE4(FOREST) / MODE5(TIME) / MODE6(WIRE-FRAME)

You have a choice of 6 different background textures preset at the factory. Select them following the procedure below.

Setting Automatic Background Textures

Setting item: AUTO BACK GND

Setting content: OFF / ON

Turn on the Automatic Background Texture Scroll to automatically change background texture. The background texture will change each time the ignition key is turned off and turned back on again (6 textures).

ON: Turn on the Auto Background Texture Scroll mode. The background textures will scroll when the ignition key is turned off once and turned back on again as follows:
WATER → WOOD → SKY → FOREST → TIME → WIRE-FRAME → WATER

OFF: Turn off the Auto Background Texture Scroll mode.

Navigation System (Optional)

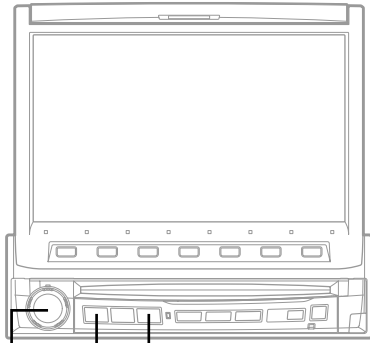

Rotary encoder
V.SEL
SOURCE/POWER

Auxiliary Device (Optional)

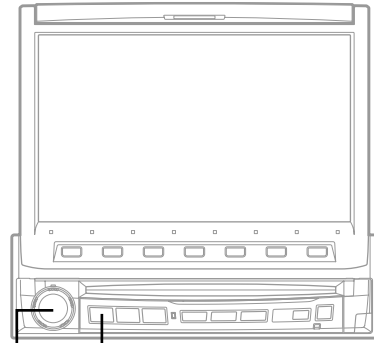

Rotary encoder
SOURCE/POWER

Controlling the Navigation System (Optional)

If an optional Alpine Navigation System is connected to the IVA-D900, some of its functions can be controlled from the IVA-D900.

- 1 Press SOURCE/POWER.**
The main menu screen appears on the display.
- 2 Turn the Rotary encoder and select "NAV.", then press the Rotary encoder to execute the selection.**

The Function Guide display changes to show the same button names as those for the remote control supplied.

- When **V. SEL** is pressed while the Navigation selection mode is being selected in "Setting Visual Mode" (refer to page 32), the navigation mode will be directly activated.
- If the Navigation mode menu is not displayed on the main menu screen, set NAV. IN to on by following "Setting the navigation mode" (page 33).
- If you use the buttons displayed, you can control the navigation system from IVA-D900 in the similar way to the remote control operation.
For operation, refer to the Owner's Manual for your navigation system.
- Depending on the navigation system connected to this unit, some functions and displays may vary.
- When the Navigation System is on, the audio and visual navigation cuts in.

Operating Auxiliary Devices (Optional)

To operate your devices connected to the AUX terminals on the rear panel of IVA-D900, follow the procedure described below.

WARNING

It is dangerous (and illegal in many states) for the driver to watch the TV/Video while driving the vehicle. The driver may be distracted from looking ahead and an accident could occur.

Install the IVA-D900 correctly so that the driver cannot watch TV/Video unless the vehicle is stopped and the emergency brake is applied.

If the IVA-D900 is not installed correctly, the driver will be able to watch the TV/Video while driving the vehicle and may be distracted from looking ahead and cause an accident. The driver or other people could be severely injured.

To activate your auxiliary devices:

To watch a video source, your vehicle must be parked with the ignition key in the ACC or ON position. To do this, follow the procedure below.

1. Bring your vehicle to a complete stop at a safe location. Engage the parking brake.
2. Keep pushing the foot brake and release the parking brake once then engage it again.
3. When the parking brake is engaged for the second time, release the foot brake.

- For automatic transmission vehicles, place the transmission lever in the Park position.

Now, the locking system for the AUX mode operation has been released. Engaging the parking brake can reactivate the AUX mode, as long as the car's ignition has not been turned off. It is not necessary to repeat the above procedure (1 through 3), of "To activate your auxiliary devices."

Each time the ignition is turned OFF, perform the procedure of "To activate your auxiliary devices."

- If you try to activate the auxiliary device while driving, the display will show the warning-**PICTURE OFF FOR YOUR SAFETY**.

1 Press **SOURCE/POWER**.

The main menu screen appears on the display.

2 Turn the **Rotary encoder** and select "AUX," then press the **Rotary encoder** to execute the selection.

- If the AUX mode is not displayed on the main menu, set AUX IN to LEVEL LOW or HIGH by following "Setting the AUX mode" (page 33).

Changer (Optional)

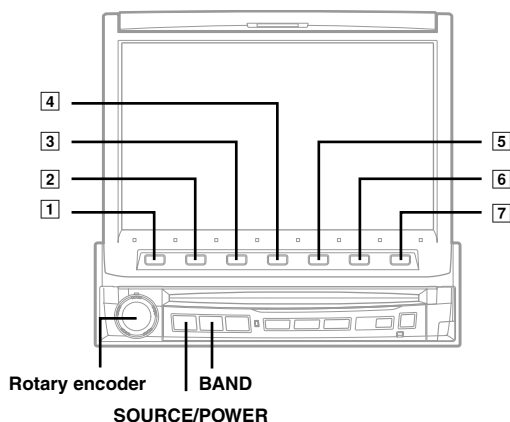

Controlling CD Changer (Optional)

An optional 6-disc or 12-disc CD Changer may be connected to the IVA-D900 if it is Ai-NET compatible. With a CD Changer connected to the Ai-NET input of the IVA-D900, the CD Changer will be controllable from the IVA-D900.

If you connect a changer compatible with MP3, you can play CD-ROMs, CD-Rs, and CD-RWs containing MP3 files on the IVA-D900.

Using the KCA-400C (the Multi-Changer Switching device) multiple changers can be controlled by the IVA-D900.

See the Multi-Changer Selection section for selecting the CD Changers (page 38).

1 Press **SOURCE/POWER** to display the main menu.

2 Turn the **Rotary encoder** to select "CD CHG," then press the **Rotary encoder**.

The display changes to the CD changer mode screen.

3 When a 6 Disc CD Changer is connected;

- 1 Press **[7]** (**PAGE 1/2**).
The Function Guide display changes.
- 2 Press the Function buttons to select your desired disc loaded.
The Function buttons **[1]** (**DISC1**) through **[6]** (**DISC6**) select the discs from the first disc to 6th disc.

When an MP3 compatible CD changer is connected;

- 1 Press **[7]** (**PAGE 1/3**) twice to change the Function Guide display.
- 2 Press the Function buttons to select your desired disc among the loaded ones.
The Function buttons **[1]** (**DISC1**) through **[6]** (**DISC6**) select the discs from the first disc to 6th disc.

Continued

When a 12-Disc CD Changer is connected;

You can select the disc numbers 1 to 6 in the same manner as for 6-disc Changer.

Press [7] (PAGE 1/3) twice to select the disc numbers 7 to 12.

The Function Guide display changes and now the Function buttons 1-6 represent disc numbers 7-12.

- After selecting the desired setting, you can operate in the same way as for the CD player. For details, see the CD/MP3 section
- Press **BAND** to switch the Disc mode in the CD/DVD/Changer mode.
- When an MP3 compatible CD changer is connected, the unit can play discs containing both audio data and MP3 data.
- The DVD changer (optional) is controllable from the IVA-D900 as well as the CD changer.

Multi-Changer Selection (Optional)

Alpine's Ai-NET system will support up to 6 CD Changers. When operating two or more changers, the KCA-400C (Multi-Changer Switching device) must be used. If you use 1 Switching device, you can connect up to 4 CD Changers. If you use 2 Switching devices, you can connect up to 6 CD Changers. When using KCA-410C (Versatile Link Terminal), you can connect two changers only.

1 Press **SOURCE/POWER** to display the main menu.

2 Turn the **Rotary encoder** to select a desired changer.

The display shows the selected CD changer mode screen.

- When one KCA-400C is connected to the changer, "Changer 1-4" is displayed in the main menu. When two KCA-400Cs are connected to the changer, "Changer 1-6" is displayed in the main menu. When one KCA-410C is connected to the changer, "Changer 1-2" is displayed in the main menu.
- In Changer mode, you can select the next changer (connected changers only) by pressing **BAND** on the unit or on the remote.
- You cannot operate this function in the Title display or Title Inputting display.

3 To operate the selected changer, see "CD/MP3" section.

- To operate the selected changer, see "CD/MP3"(pages 12-13).

XM Radio (Optional)

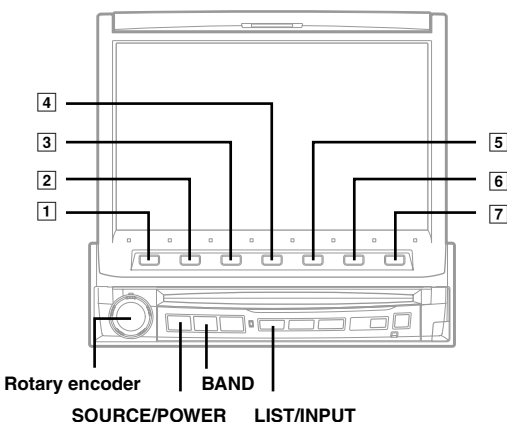

Receiving XM Channels with the XM Receiver (Optional)

XM Satellite Radio* is the next generation of audio entertainment, with up to 100 brand-new digital channels. For a small monthly fee, subscribers can hear crystal-clear music, sports, news and talk, coast-to-coast via satellite. For more information, visit XM's website at www.xmradio.com or call 1-800-852-9696.

An optional XM Satellite Radio Receiver (TUA-T021XM) and an optional XM Antenna may be connected to the IVA-D900. With an XM Receiver connected to the Ai-NET input of the IVA-D900, the XM Receiver will be controllable from the IVA-D900.

* XM and its corresponding logos are trademarks of XM Satellite Radio Inc.

- The controls on the IVA-D900 for XM Receiver operation are operative only when an XM Receiver is connected.

1 Press **SOURCE/POWER**.

The main menu is displayed.

2 Turn the **Rotary encoder** to select "XM," then press the **Rotary encoder**.

3 Press **BAND** to select XM1, XM2 or XM3.

4 Press [2] (**NO./NAME**) to select the channel number tuning.

Each time it is pressed, the tuning mode is changed.
channel number tuning ↔ channel name tuning

5 Press [1] (◀ **CH NO. DN**) or [3] (**CH NO. UP** ▶) to select the desired channel. Holding either button down will change channels continuously.

When you select the channel name tuning in step 4, press [1] (◀ **CH NAME DN**) or [3] (**CH NAME UP** ▶) to select a channel name.

Tuning in to Categorized Programs

You can listen to programs categorized to the same group one after another.

- 1 In XM mode, press [4] (CAT).**
The category of the current program is displayed.
- 2 Press [2] (CH/CAT) to select the category tuning.**
Each time it is pressed, the tuning mode is changed.
Channel number tuning ↔ Category tuning
- 3 While the category name is displayed, press [1] (◀CAT DN) or [3] (CAT UP▶) to select a desired category.**
The selected category is tuned.
 - When you select Channel number tuning in step 2, press the [1] (◀CH DN) or [3] (CH UP▶) button to select a channel number.
 - If the desired category program is not found, the selected category is displayed for 5 seconds, then the receiving program is restored.

Changing the Display

Text information, such as the channel name, artist name/feature, and song/program title, is available with each XM channel. The unit can display this text information as explained below.

In XM mode, press [5] (TITLE).

Each time you press this button, the display changes as shown below.

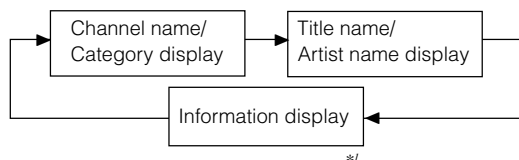

**1 Channel number, category, title name, etc., are displayed in one screen.*

- By pressing [5] (TITLE) for more than 2 seconds during each display mode above, the Auxiliary Data Field appears.

Checking the XM Radio ID Number

You need to provide XM with the unique XM Radio ID number for your XM Radio Receiver in order to subscribe to XM's programming.

This number is an 8 character alphanumeric number that is printed on a label directly on the XM Receiver.

It can also be displayed on the screen of the IVA-D900 in the following way.

- 1 While receiving XM1/XM2 or XM3, press [1] (◀ CH NO. DN) or [3] (CH NO. UP▶) to select channel "0."**
- 2 The unit displays the ID number.**
- 3 To cancel the ID number display, set the channel to other than "0."**
 - You cannot use "O," "S," "I," or "F" for the ID Number.
 - You can check your ID number printed on the label on the package of your XM Satellite Radio Receiver (TUA-T021XM).

Storing XM Channel Presets

- 1 Press BAND to select the desired band (XM1, XM2 or XM3) you want to store.**
- 2 Press [7] (PAGE 1/2).**
The Function Guide is switched.
- 3 After tuning in the desired channel, press and hold (for at least 2 seconds) any one of the Preset buttons (1 through 6) into which you want to store the channel. The selected channel is stored.**
- 4 Repeat the procedure to store up to 5 other channels onto the same band.**
To use this procedure for other bands, simply select the desired band and repeat the procedure.
A total of 18 channels can be stored in the preset memory (6 channels for each band; XM1, XM2 and XM3).
 - If you store a channel in a preset already being used, the current channel will be replaced with the new one.

Receiving Stored XM Channels

- 1 Press BAND to select the desired band (XM1, XM2 or XM3).**
- 2 Press [7] (PAGE 1/2).**
The Function Guide is switched.
- 3 Press the Channel Preset button that has your desired satellite channel in memory.**

Displaying the Category/Channel Name Title List

- 1 In XM mode, press LIST/INPUT.**
The category title list is displayed.
- 2 Turn the Rotary encoder to move the cursor to the desired category.**
- 3 Press the Rotary encoder.**
The lowest channel in the selected category is tuned.

To display the channel name list

- While the title List is displayed in step 2 above, press **[6] (NEXT ►)**.
The channel name in the selected category is switched to the list display.
By pressing **[5] (◀ BACK)**, the display returns to the previous category title list.
- Turn the **Rotary encoder** to select the desired channel name.
- Press the **Rotary encoder**.
The selected channel name program is tuned.

MobileHub™ Link (Optional)

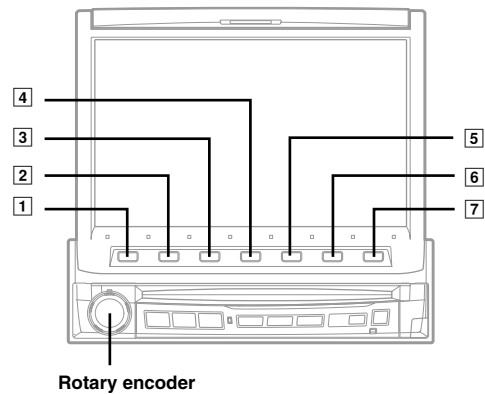

About MobileHub™ Link (Optional)

Connect a separately sold junction box and a portable telephone (available from Nokia) to control the incoming and outgoing calls of the portable telephone.

CAUTION

- Even with hands-free operation, a driver can be distracted during telephone operation or receiving a call. For the sake of safety, drivers are requested to refrain from operating the telephone while driving.
- For the sake of safety, operations other than incoming calls and Speed-Dial outgoing calls cannot be used.

- If a portable telephone is connected, its address book, incoming and outgoing history, short message history and standardized sentences are downloaded to the junction box.
Please refer to the instruction manual of the junction box.
- When a portable telephone is not connected, "NO PHONE" is displayed for at least 5 seconds, then the mode returns to the original source mode.
- When the portable telephone is taken off the junction box during an incoming or outgoing call, or during a hands-free call, the call will be treated as an ordinary one by the portable telephone.
- When there is an incoming call while the power of IVA-D900 is OFF, the power of IVA-D900 will turn ON automatically for a hands-free call.
- Even if the power of the portable telephone is OFF, when IVA-D900 is set to the telephone mode, the power of the portable telephone will be turned ON.
- Even if the ACC power of the vehicle is turned OFF (the engine is stopped) during a hands-free call, the call is not disconnected, and an ordinary call by the portable telephone is possible.
- If there is an incoming call during operation (except an outgoing call or talking), operation mode will end and switch to the incoming or talking mode.
- An outgoing call from a portable telephone is also possible.
However, you cannot perform different operations at the same time from a portable telephone and IVA-D900 as malfunction can result.

- With a junction box connected outgoing, incoming, and sending history will also be recorded in the portable telephone.
- While telephoning, Time Correction is set to normal (0.0ms) and DEFEAT is also set to ON. When the call has finished, the unit returns to the setting which you previously set.
- The telephone volume can be adjusted from the IVA-D900. The volume you set during the call is memorized, and is automatically applied again on the next call.

Telephone Reception

- 1** When this unit receives a call, the screen is switched to RINGING display of Telephone mode.
- 2** When AUTO call (setting of AUTO/MANUAL call page 32) is selected, CONNECT display appears and this unit enters AUTO call mode in 3 seconds after receiving.
- 3** To cut the call, press **[2]** (). Or the call is automatically cut in 5 seconds after finishing.
The screen returns to the previous source mode.



To input any number or symbol during call:

- 1 Press **[3]** (TENKEY MODE) in the CONNECT display.
The DIAL Sending display appears.
- 2 Turn the **Rotary encoder** to select your desired Number or symbol, then press the **Rotary encoder** to enter it.
- 3 Press **[7]** (RETURN) to return the previous screen.

Calling

Calling by using the Speed Dial

You can place a call by retrieving one of the telephone numbers registered in No. 1 to 9 of the address book.

- 1** Press the **Rotary encoder** for more than 2 seconds.
The Speed Dial display appears.
 - 2** Press the desired function button.
If the telephone numbers have been registered in No.6 to 9, press **[6]** (6 - 9).
The Function Guide is switched to the function buttons **[1]** (6) to **[4]** (9).
 - 3** Press **[1]** () to start call.
 - 4** To cut the call, press **[2]** (). Or the call is automatically cut in 5 seconds after finishing.
- If no telephone number is registered in the selected function button, "NO PRESET" is displayed for 5 seconds.
Press **[7]** (RETURN) to return to the Telephone menu display.
 - When **[1]** (SPEED DIAL) is pressed in the Telephone menu display, the Speed Dial display appears.
 - By pressing your desired function button for more than 2 seconds in step 2, you can start call directly.

Dial call

Input the telephone number using the dial.

- 1** Press and hold the **Rotary encoder** for more than 2 seconds.
The Speed Dial display appears.
- 2** Press **[7]** (RETURN).
The Telephone menu display appears.
- 3** Press **[4]** (DIRECT CALL).
The Direct Call display appears.
- 4** Turn the **Rotary encoder** to select the desired number, then press the **Rotary encoder** to enter the first digit.
◀BACK or NEXT▶: The cursor on the input number moves left or right.
DELETE: Deletes a blank space or a number.
Pressing more than 2 seconds deletes all input numbers.
- 5** Press **[1]** (CALL) to start call.

- The call is cut in 5 seconds after "NO NETWORK COVERAGE" is displayed. Or press **[2]** () to cut the call.

To listen to the answer-phone or to input numbers:

- 1 In the CONNECT display, press **[3]** (TENKEY MODE).
The Dial Sending display appears.
- 2 Turn the **Rotary encoder** to select your desired Number or symbol, then press the **Rotary encoder** to enter it.
- 3 Press the **[7]** (RETURN) button to return to the previous screen.

- 6** To cut the call, press **[2]** (). Or the call is automatically cut in 5 seconds after finishing.
The screen returns to the previous source mode.

- If **[7]** (RETURN) is pressed in 5 seconds after the call is cut, the Telephone menu display appears.
- When the call is cut, pressing **[1]** () dials the number again.

Continued

Calling by the address book

From your vehicle, call from the address book registered in the portable telephone.

1 Press and hold the Rotary encoder for more than 2 seconds.

The Speed Dial display appears.

2 Press [7] (RETURN).

The Telephone menu display appears.

3 Press [2] (PHONE BOOK).

The Phone Book display appears.

4 Turn the Rotary encoder to select a receiver, then press the Rotary encoder .

The Select display appears.

- By pressing [1] (ALPHABET DN) or [2] (ALPHABET UP), the names are listed in alphabetical order.
- If no data is in the PHONE BOOK, "NO MEMORY" is displayed.
Press [7] (RETURN) to return to the Telephone menu display.

5 Press [1] () to place the call.

6 To cut the call, press [2] (). Or the call is automatically cut in 5 seconds after finishing.

Calling by the outgoing / incoming / absent incoming history

You can place a call to one of the last 999 calls by the outgoing/incoming/absent incoming history.

1 Press and hold the Rotary encoder for more than 2 seconds.

The Speed Dial display appears.

2 Press [7] (RETURN).

The Telephone menu display appears.

3 Press [3] (CALL LOG).

The Call log display appears.

4 Press either [1] (DIALED NUM.), [2] (MISSED CALLS) or [3] (RECEIVE CALLS).

DIALED NUM.: Outgoing history list display

MISSED CALLS: Absent incoming history list display

RECEIVE CALLS: Incoming history list display

- If no history is registered to any of the lists, NO MEMORY is displayed.

To return to Telephone menu display, press [7] (RETURN).

5 Turn the Rotary encoder to select a receiver, then press the Rotary encoder.

The Select display appears.

6 Press [1] () to start call.

7 To cut the call, press [2] (). Or the call is automatically cut in 5 seconds after finishing.

SMS (Short Message Service) Operation

You can receive messages, show the contents of messages, and send standardized sentences.

When a message is received, an icon is indicated on the display.

Receiving a Short Message

1 Press the Rotary encoder for more than 2 seconds.

The Speed Dial display appears.

2 Press [7] (RETURN).

The Telephone menu display appears.

3 Press [5] (SMS READ).

The SMS Read display appears.

4 Turn the Rotary encoder to select one of the received message.

5 Press the Rotary encoder.

The SMS Inbox display appears.

The contents of the received message is displayed up to 140 letters.

REPLY: Replies to the sender by return mail.
Standardized sentences can be selected in the display (refer to "Sending a Standardized Sentence," page 43).

USE NUMBER: Replies to the sender by phone. The Select display appears. Place a call by pressing [1] ().

RETURN: Returns to the SMS Read display.

- When the unit receives a message, the new reception icon appears.

Sending a standardized sentence

You can select a standardized sentence when you send a mail.

- 1 Press and hold the Rotary encoder for more than 2 seconds.**
The Speed Dial display appears.
- 2 Press [7] (RETURN).**
The Telephone menu display appears.
- 3 Press the [6] (SMS WRITE).**
The Standardized sentences are displayed.
- 4 Turn the Rotary encoder to select your desired sentence.**
- 5 Press the Rotary encoder.**
The Send menu display appears.
- 6 Press either [1] (PHONE BOOK) to [3] (DIRECT CALL) of the Function Guide to select the address.**

To send from the PHONE BOOK or the CALL LOG

- 7 In the phone book display or the call log display, turn the Rotary encoder to select the address. Then press the Rotary encoder to enter it.**
The select display appears.
- 8 Press [1] (SEND) to send.**
The SMS send display appears, and the mail is sent.

To send from the DIRECT CALL

- 7 In the direct call display, turn the Rotary encoder to select the number. Then press the Rotary encoder to enter it.**
- 8 Press [1] (CALL).**
The SMS send display appears and the mail is sent.

- To reply by REPLY of "SMS (Short Message Service) Operation" (page 42), press [6] (SEND) on the Send menu display to send.
- If TEL mode is canceled by power off, etc., in the middle of making a short message, the unfinished message is not saved.

External Audio Processor (Optional)

When an external audio processor is connected to this unit, you can operate it from this unit. Some audio processors may not be operated. When PXA-H510 or PXA-H900 is connected, some of the operations may not be performed from this unit. In this case, operate them in the connected product. Explanations below is the case when PXA-H700 is connected for example.

Refer also to the operating instructions of the connected audio processor.

- While your car is running, only A.PROC list is displayed. Carry out the operation related to any setting while your car stops.
- The adjustments or settings performed on the connected audio processor cannot be operated properly from this unit.

To display the Audio processor mode screen:

To watch a video source, your vehicle must be parked with the ignition key in the ACC or ON position. To do this, follow the procedure below.

1. Bring your vehicle to a complete stop at a safe location. Engage the parking brake.
2. Keep pushing the foot brake and release the parking brake once then engage it again.
3. When the parking brake is engaged for the second time, release the foot brake.

- For automatic transmission vehicles, place the transmission lever in the Park position.

Now, the locking system for the Audio processor mode operation has been released. Engaging the parking brake can reactivate the Audio processor mode, as long as the car's ignition has not been turned off. It is not necessary to repeat the above procedure (1 through 3), of "To display the Audio processor mode screen."

Each time the ignition is turned OFF, perform the procedure of "To display the Audio processor mode screen."

Adjustment Procedure for Dolby Surround

Make the adjustments described below in order to reproduce Dolby Digital and DTS sound with greater accuracy.

Adjustment procedure

- 1 **Speaker setup (page 48)**
(Turning the speakers to be used on and off and setting their response)
- 2 **Adjusting the speaker levels (page 50)**
(Adjusting the signal output level to the various speakers)
- 3 **Mixing bass sound to the rear channel (page 49)**
(Achieving smooth sound in the rear seat by mixing the front audio signals with the rear speaker signals)
- 4 **Adjusting the acoustic image (page 49)**
(Adjusting the acoustic image to achieve a sound as if the center speaker were directly in front of the listener)
- 5 **Achieving powerful high volume sound (page 49)**
(Achieving energetic sound with even greater power, like the sound in a movie theater)
- 6 **Adjusting the DVD level (page 50)**
(Adjust the volume (signal level) in the Dolby Digital, Pro Logic II, DTS and PCM modes.)
- 7 **Storing settings in the memory (page 50)**
(Storing all the settings and adjustments made on the IVA-D900 (not only the above settings/adjusts) in the memory)

In case of combining the Automatic adjustments etc.

We recommend to make the Automatic adjustments before the Dolby Surround adjustments.

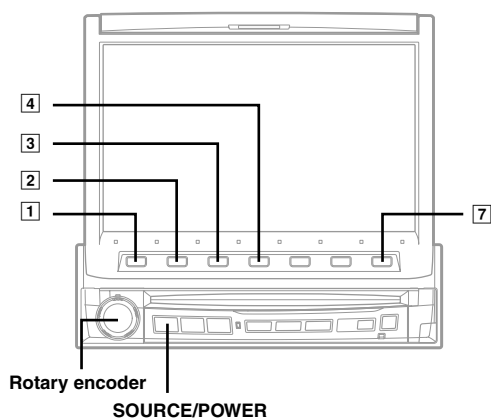

Setting the Speakers

- 1 Check that defeat mode is off.**
 - 2 Press SOURCE/POWER.**
The main menu is displayed.
 - 3 Press [4] (A.PROC).**
The A.PROC (Audio processor) list display appears.
 - 4 Turn the Rotary encoder to select SPEAKER SELECT.**
The Function Guide changes.
 - 5 Press [1] (SETUP).**
The SPEAKER SELECT list display appears.
 - 6 Turn the Rotary encoder to select a speaker to be set.**
The Function Guide changes.
 - 7 Press the function button to set the selected speaker.**
FRONT1: OFF/FULL (Full Range)/TW (Tweeter)
FRONT2: OFF/ON
REAR: OFF/ON
CENTER/SUBW.:
CENTER OFF/ON
SUB W. (Subwoofer) OFF/MONO/STEREO
- Set the speaker which is not connected to OFF.
 - Settings above can be carried out even when the speaker is set to OFF in "Speaker Setup."
 - In order to protect the speakers, if Tweeter is selected in Front 1, there is no filter OFF (slope OFF) setting for H.P.F.
For the same reason, the subwoofer low pass filter cannot be turned off (the slope cannot be set to "OFF").
 - To use the subwoofer in MONO with PXA-H700 connected, connect the subwoofer to the subwoofer output terminal of PXA-H700.

Set MX Mode of the External Audio Processor

Before performing the operations below, set MX (Media Xpander) mode of the external audio processor to "AUTO."

- 1 Check that defeat mode is off.**
- 2 Press SOURCE/POWER.**
The main menu is displayed.
- 3 Press [4] (A.PROC).**
The A.PROC (Audio processor) list display appears.
- 4 Turn the Rotary encoder to select "Media Xpander."**
The Function Guide changes.
- 5 Press [2] (ON), then press [3] (SETUP).**
The MX list display appears.
OFF: To cancel MX mode for all music sources
- 6 Turn the Rotary encoder to select your desired MX mode.**
The screen shows the *Function Guide.
* Displays the function assigned for each button.
- 7 Press the Function button to switch the setting.**
The level of the audio source can be adjusted. It is after switching the audio source that the MX mode is applied.
 - MX CD (OFF, CD 1 to 3)**
CD mode processes a large quantity of data. This data is used to reproduce the sound cleanly by making use of the data quantity.
 - MX MP3 (OFF, MP3 1 to 3) / MX XM (OFF, XM 1 to 3) / MX MD (OFF, MD 1 to 3)**
This corrects information that was omitted at the time of compression. This reproduces a well-balanced sound close to the original.
 - MX FM (OFF, FM 1 to 3)**
The medium to high frequencies become more clear, and produces well balanced sound in all the bands.
 - MX DVD (OFF, MOVIE 1 to 2)**
The dialog portion of the video is reproduced more clearly.
 - (DVD MUSIC)**
This disk contains a large quantity of data such as music clip. MX uses this data to reproduce the sound accurately.
 - MX AUX 1 to 3 (OFF, MP3, MOVIE, MUSIC)**
Choose the MX mode (MP3, MUSIC, or MOVIE) that corresponds to the media connected.
- To return to the previous display, press [7] (RETURN).
- 8 Press the function button to set the MX mode.**
 - The contents of MX set here is reflected to PXA-H700.
 - When OFF is selected, MX effect of each MX mode will be OFF.
 - Each music source, such as radio, CD, and MP3 can have its own MX setting.
 - MX mode does not function when MX is ON for AM radio.
 - XM, MD or AUX is displayed only when each product is connected.

Performing Time Correction Manually (TCR)/ Switching the Phase

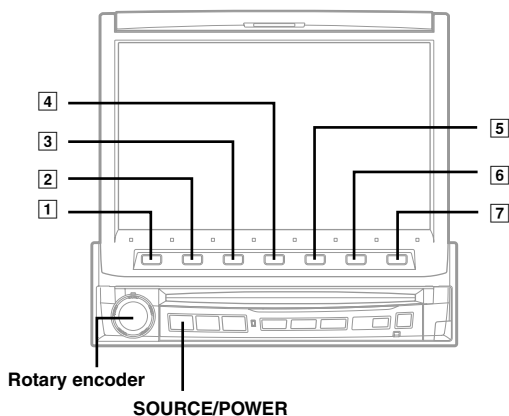

Because of the particular conditions inside the vehicle, there can be major differences in the distances between the various speakers and the listening position. It is possible to calculate the optimum correction values and eliminate the time error at the listening position yourself using this function. You can also use this function to switch the phase.

- 1** Check that Defeat mode is off.
- 2** Sit in the listening position (the driver's seat, for example) and measure the distance (in meters) between your head and the various speakers.
- 3** Calculate the difference in distance between the farthest speaker and the other speakers.

$$L = (\text{distance of farthest speaker}) - (\text{distance of other speakers})$$
- 4** Divide the distances calculated for the different speakers by the speed of sound (343 m/s temperature 20°C).

This value is the time correction value for the various speakers.

Concrete examples

Calculating the time correction value for the front left speaker on the diagram below.

Conditions:

Distance between farthest speaker and listening position:
2.25 m (88-3/4")

Distance between front left speaker and listening position:
0.5 m (20")

Calculation:

$$L = 2.25 \text{ m (88-3/4")} - 0.5 \text{ m (20")} = 1.75 \text{ m (68-3/4")}$$

$$\text{Compensation time} = 1.75 \div 343 \times 1000 = 5.1 \text{ (ms)}$$

In other words, setting the time correction value for the front left speaker to 5.1 (ms) sets a virtual distance matching the distance to the farthest speaker.

X-OVER Adjustment

- 1** Check that defeat mode is off.
- 2** Press **SOURCE/POWER**.
The main menu is displayed.
- 3** Press **[4] (A.PROC)**.
A.PROC (Audio processor) list display appears.
- 4** Turn the **Rotary encoder** to select "X-OVER."
- 5** Press **[1] (SETUP L/R)** or **[2] (SETUP L+R)**.
X-OVER adjustment display appears.
L/R: Different adjustment values can be set for the left and right channels.
L+R: Sets the same adjustment values for the left and right channels.
- 6** Turn the **Rotary encoder** to select the speaker to be set.
- 7** Press the function button to adjust the selected speaker.
 FREQ. **<DN/UP>**: Adjust the H.P.F. or L.P.F. cutoff frequency.
 The adjustable bands differ according to the channel (speaker).
 SLOPE **<DN/UP>**: Adjust the H.P.F. or L.P.F. slope.
 LEVEL **<DN/UP>**: Adjust the level.
- 8** Repeat steps 6 and 7 to adjust other channels.
- 9** Press **[7] (RETURN)** to return to the previous display.

- When the speaker is set to the "OFF" mode, X-OVER for that speaker cannot be set. Refer to "Setting the Speakers" (page 45).
- Check the playback frequencies of the connected speakers before adjusting.

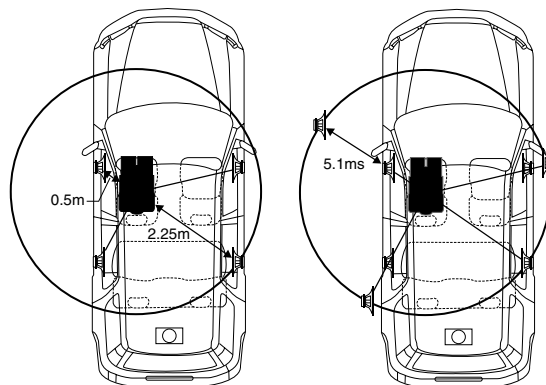

The sound is uneven because the distance between the listening position and the different speakers is different. The difference in the distance between the front left and rear right speakers is 1.75 meters (68-3/4").

Time correction eliminates the difference between the time required for the sound from the different speakers to reach the listening position. Setting the time correction of the front left speaker to 5.1 ms makes it possible to coordinate the distance from the listening position to the speaker.

- 5 Press **SOURCE/POWER**.
The main menu is displayed.
- 6 Press **[4] (A.PROC)**.
A.PROC (Audio processor) list display appears.
- 7 Turn the **Rotary encoder** to select **"TCR/PHASE"**.
The Function Guide changes.
- 8 Press **[1] (SETUP L/R)** or **[2] (SETUP L+R)**.
TCR/PHASE adjustment display appears.
L/R: Different adjustment values can be set for the left and right channels.
L+R: Sets the same adjustment values for the left and right channels.
- 9 Turn the **Rotary encoder** to select a speaker to be set.
- 10 Press the **[1] (TIME ◀ DN)** or **[2] (TIME UP ▶)** to adjust the time revision value.
- 11 Press **[3] (0°)** or **[4] (180°)** to switch phase.
- 12 Repeat steps 9 to 11 to adjust other channels.
- 13 Press **[7] (RETURN)** to return to the previous display.

- When the speaker is set to the "OFF" mode, the TCR for that speaker cannot be set. Refer to "Setting the Speakers" (page 44).

Graphic Equalizer Adjustments

The graphic equalizer allows you to modify the sound using 31 bands each for the front (left and right), rear (left and right) and center speakers. An additional 10 bands are available for the subwoofer. This allows you to customize the sound to suit your taste.

- 1 Check that the Defeat mode is off.
- 2 Press **SOURCE/POWER**.
The main menu is displayed.
- 3 Press **[4] (A.PROC)**.
The A.PROC (Audio processor) list display appears.
- 4 Turn the **Rotary encoder** to select **"G.EQ (Graphic EQ)"**.
The Function Guide changes.
- 5 Press **[2] (ON)**, then press **[3] (SETUP L/R)** or **[4] (SETUP L+R)**.
G.EQ adjustment display appears.
L/R: Different adjustment values can be set for the left and right channels.
L+R: Sets the same adjustment values for the left and right channels.

When you do not adjust it, set to OFF.
- 6 Press the function button of your desired speaker (channel).
The Function Guide changes.
- 7 Turn the **Rotary encoder** to select a frequency to be adjusted.
- 8 Press **[1] (LEVEL ◀ DN)** or **[2] (LEVEL UP ▶)** to adjust the level.
Press **[7] (RETURN)** to return to the Function Guide in step 6.
- 9 Repeat steps 6 to 8 to adjust other frequencies.

- When the speaker is set to the "OFF" mode, the graphic equalizer for that speaker cannot be set. Refer to "Setting the Speakers" (page 45).
- Check the playable frequency ranges of the connected speakers before making the equalizer adjustments. If the speaker's playable frequency range is 55 Hz to 30 kHz, for example, adjusting the 40 Hz or 20 Hz band has no effect. Additionally, you may overload and damage the speakers.
- When graphic EQ is adjusted, the adjustment for parametric EQ becomes ineffective.

Parametric Equalizer Adjustments

The frequency bands of the graphic equalizer are fixed. This makes it very difficult to correct for undesired peaks and dips at specific frequencies. The parametric equalizer's center frequency can be tuned to these specific frequencies. Then, the bandwidth (Q) and level are fine-tuned, independently, to make the necessary corrections. The parametric equalizer function is an advanced tool for serious audiophiles.

- 1 Check that Defeat mode is off.
 - 2 Press **SOURCE/POWER**.
The main menu is displayed.
 - 3 Press **[4] (A.PROC)**.
The A.PROC (Audio processor) list display appears.
 - 4 Turn the **Rotary encoder** to select **"P.EQ (Parametric EQ)"**.
The Function Guide changes.
 - 5 Press **[2] (ON)**, then press **[3] (SETUP L/R)** or **[4] (SETUP L+R)**.
P.EQ adjustment display appears.
L/R: Different adjustment values can be set for the left and right channels.
L+R: Sets the same adjustment values for the left and right channels.

When you do not adjust it, set to OFF.
 - 6 Press the function button of your desired speaker (channel).
The Function Guide changes.
 - 7 Turn the **Rotary encoder** to select a frequency to be adjusted.
 - 8 Press the function button to adjust as follows.
FREQ. ◀DN or UP▶: Selects the frequency.
LEVEL ◀DN or UP▶: Adjusts the level.
WIDTH ◀DN or UP▶: Adjust the band width.

Press **RETURN** to return to the function guide in step 6.
 - 9 Repeat steps 6 to 8 to adjust other bands.
- When the speaker is set to the "OFF" mode, the parametric equalizer for that speaker cannot be set. Refer to "Setting the Speakers" (page 45).
 - It is not possible to adjust the frequencies of adjacent bands within 7 steps.
 - Check the playable frequency ranges of the connected speakers before making the equalizer adjustments. If the speaker's playable frequency range is 55 Hz to 30 kHz, for example, adjusting the 40 Hz or 20 Hz band has no effect. Additionally, you may overload and damage the speakers.
 - When the parametric EQ is adjusted, the adjustment for graphic EQ becomes ineffective.

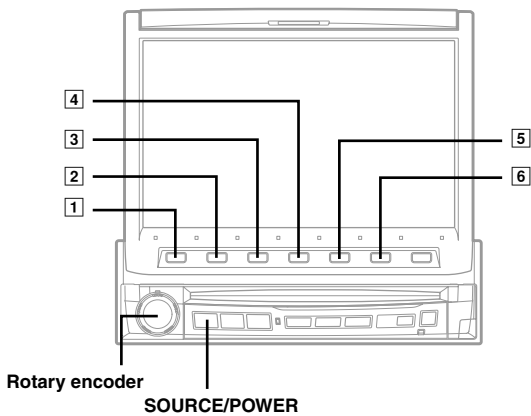

BASS COMP. Setting

The sound of low frequencies can be adjusted to suit your tastes.

- 1 Check that the Defeat mode is off.**
- 2 Press SOURCE/POWER.**
The main menu is displayed.
- 3 Press [4] (A.PROC).**
The A.PROC (Audio processor) list display appears.
- 4 Turn the Rotary encoder to select "BASS SOUND CONT."**
The Function Guide changes.
- 5 Press [1] (SETUP).**
Bass Sound list display appears.
- 6 Turn the Rotary encoder to select "BASS COMP".**
The Function Guide changes.
- 7 Press the function button of your desired mode.**
As the bass level increases in order of MODE1 - 3, you can enjoy listening to powerful sound.

When you do not adjust any of them, set to OFF.

Bass Focus

The time difference between the front-rear/left-right speakers, can be adjusted a pair at a time. Audible time correction can be made from 0.10 ms to 20.00 ms in 201 steps (0 to 200).

- 1 Check that the Defeat mode is off.**
- 2 Press SOURCE/POWER.**
The main menu is displayed.
- 3 Press [4] (A.PROC).**
The A.PROC (Audio processor) list display appears.
- 4 Turn the Rotary encoder to select "BASS SOUND CONT."**
The Function Guide changes.
- 5 Press [1] (SETUP).**
The Bass Sound Cont list display appears.
- 6 Turn the Rotary encoder to select "BASS FOCUS."**
The Function Guide changes.
- 7 Press [3] (FRONT), [4] (LEFT), [5] (RIGHT) and [6] (REAR) to select the front, rear, left and right speakers.**
- 8 Press [1] (TIME ◀ DN) or [2] (TIME UP ▶) to set the step of front/rear and left/right.**
- 9 For setting another channel (speaker), repeat steps 7 and 8.**

- The setting mode in Bass Focus is reflected in the time correction.

Speaker Setup

The PXA-H700 can be set according to the playable frequency range of your speakers.

Check the playable frequency range of the speakers (not including the subwoofer) before performing this operation to verify whether the speakers can play low frequencies (of about 80 Hz or less).

- Avoid stopping, pausing, switching the disc, cueing, fast-forwarding or switching the audio channel of this unit while making this adjustment. The setting is canceled if Decode mode is switched.

- 1 Check that Defeat mode is off.**
- 2 Press SOURCE/POWER.**
The main menu is displayed.
- 3 Press [4] (A.PROC).**
The A.PROC (Audio processor) list display appears.
- 4 Turn the Rotary encoder to select "SPEAKER SETUP".**
- 5 Press [1] (SETUP).**
The SPEAKER SETUP list display appears.
- 6 Turn the Rotary encoder to select a speaker.**
- 7 Press the function button to select a speaker frequency.**
OFF*1: When no speaker is connected.
SMALL: When a speaker that cannot play low frequencies (80 Hz or less) is connected.
LARGE*2: When a speaker that can play low frequencies (80 Hz or less) is connected.

*1: It is not possible to set the front speakers to "OFF".

*2: If the front speakers are set to "SMALL", the rear and center speakers cannot be set to "LARGE."

- Subwoofer can be set to “ON” or “OFF” only.
- It is not possible to set the front speakers to “OFF.”
- If the front speakers are set to “SMALL,” the rear and center speakers cannot be set to “LARGE.”
- If the center speaker is turned “OFF,” the center channel’s audio signals are added to the audio signals output from the front speakers.
- If you set the speaker response to “OFF,” also set the speaker setting to “OFF.” (page 45.)
- Perform the setup for all the speakers (“Front,” “Center,” “Rear” and “Subwoofer”). If not, the sound may not be balanced.
- When center is set to “OFF,” the setting is ineffective even if center is set with this function.
- Through changing the settings on each speaker, a change in the output of the other speakers may occur due to the setting requirements.
- When using the PRO LOGIC II, if the rear speaker is set to “LARGE”, then there will be no output from the subwoofer.

Setting of Dolby 5.1ch

- 1 Check that Defeat mode is off.**
- 2 Press SOURCE/POWER.**
The main menu is displayed.
- 3 Press [4] (A.PROC).**
The A.PROC (Audio processor) list display appears.
- 4 Turn the Rotary encoder to select “DOLBY 5.1CH SETUP.”**
The Function Guide changes.
- 5 Press [1] (SETUP).**
The DOLBY 5.1CH SETUP list display appears.
Set the items below as you desire.

Adjusting the acoustic image

In most installations, the center speaker must be placed directly between the front passenger and driver. Using this function, the center channel information is distributed to the left and right speakers. This creates an acoustic image simulating a center speaker directly in front of each listener. Adjusting the center width in PL II MUSIC (see “Using the Pro Logic II mode,” page 51), makes this function ineffective.

- Avoid stopping, pausing, switching the disc, cueing, fast-forwarding or switching the audio channel of this unit while making this adjustment. The setting is canceled if the Decode mode is switched.
 - 1 Turn the **Rotary encoder** to select BI-PHANTOM.
 - 2 Press [2] (ON).
By pressing [1] (OFF), BI-PHANTOM is set to OFF.
 - 3 Press [3] (LEVEL ◀ DN) or [4] (LEVEL UP ▶) to adjust the level.
The level can be adjusted within the range of -5 to +5.
The higher the level, the more the position of the center speaker is shifted to the sides.
- This adjustment is effective when the setting of the center speaker to SMALL or LARGE in the speaker setup settings.
- This adjustment is ineffective when the speaker is set to CENTER OFF in “Setting the Speaker” (page 45).

Mixing bass sound to the rear channel

This function mixes the front channel audio signals to the audio signals output from the rear speakers, improving the sound in the vehicle’s rear seat.

- Avoid stopping, pausing, switching the disc, cueing, fast-forwarding or switching the audio channel of this unit while making this adjustment. The setting is canceled if the Decode mode is switched.
 - 1 Turn the **Rotary encoder** to select REAR MIX.
 - 2 Press [2] (ON).
By pressing [1] (OFF), REAR MIX is set to OFF.
 - 3 Press [3] (LEVEL ◀ DN) or [4] (LEVEL UP ▶) to adjust the level.
The level can be adjusted in five steps: -6, -3, 0, +3 and +6. The higher the level, the more bass is output from the rear speakers. (The effect differs according to the software (DVD, etc..))

- This adjustment is ineffective when the rear speaker setup setting is set to “OFF.”
- For linear PCM signals, the voice is output from the rear speaker regardless of the REAR FILL and REAR MIX setting.

Achieving powerful high volume sound

With Dolby Digital, the dynamic range is compressed so that powerful sound can be achieved at regular volume levels. This compression can be canceled to achieve an energetic sound with even greater power, like the sound in a movie theater.

This function works only in the Dolby Digital mode.

- 1 Turn the **Rotary encoder** to select LISTENING MODE.
 - 2 Press [1] (STD) or [2] (MAX).
STD: For powerful sound at regular volume levels
MAX: For powerful sound at high volumes
- Keep the volume to a level at which sounds outside the vehicle can still be heard.

Continued

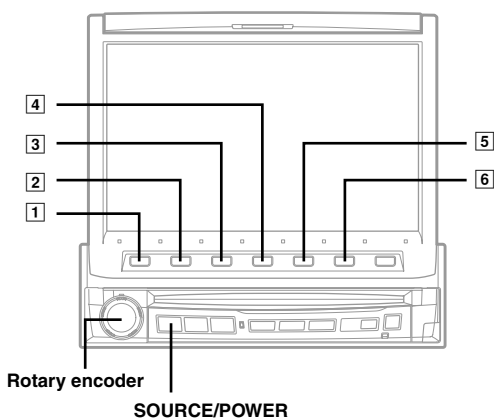

Adjusting the speaker levels

The test tones help to make the volume adjustments of the different speakers. When levels are equal, a strong sense of presence can be heard from the different speakers at the listening position.

- *Avoid stopping, pausing, switching the disc, cueing, fast-forwarding or switching the audio channel of this unit while making this adjustment. The setting is canceled if the decode mode is switched.*

- 1 Turn the **Rotary encoder** to select OUTPUT LEVEL.
- 2 Press **[1] (AUTO)**.
Test tone output is repeated for each of the different speaker channels. They will be repeated in the order shown below.
If no operation is performed for 2 seconds, the channel switches to the next channel.
Left → Center → Right → Right Surround → Left surround → Left
- 3 While the test tones are being produced from the speakers, press **[2] (LEVEL ◀ DN)** or **[3] (LEVEL UP ▶)** to adjust so that the volume of the different speakers is equal.
 - The adjustment range for the different speakers is -10 dB - +10 dB.
 - Adjust based on the front speakers.

- *If a speaker is set to off mode, that speaker's level adjustment cannot be made.*
Refer to "Speaker Setup" (page 48).

Adjusting the DVD Level

The volume (signal level) for Dolby Digital, Dolby PL II, DTS and PCM modes can be set.

- *Avoid stopping, pausing, switching the disc, cueing, fast-forwarding or switching the audio channel of this unit while making this adjustment. The setting is canceled if the Decode mode is switched.*

- 1 **Check that Defeat mode is off.**
- 2 **Press SOURCE/POWER.**
The main menu is displayed.
- 3 **Press [4] (A.PROC).**
The A.PROC (Audio processor) list display appears.
- 4 **Turn the Rotary encoder to select "DVD LEVEL."**
- 5 **Press [1] (SETUP).**
The DVD LEVEL list display appears.
- 6 **Turn the Rotary encoder to select a mode to be adjusted.**
- 7 **Press [1] (LEVEL ◀ DN) or [2] (LEVEL UP ▶) to adjust the level.**
The level can be adjusted in the range of -5 to +5.

Storing Settings in the Memory

Adjustment or setting contents can be stored.

Contents that can be stored vary depends on the audio processor used.

- 1 **Check that Defeat mode is off.**
- 2 **Press SOURCE/POWER.**
The main menu is displayed.
- 3 **Press [4] (A.PROC).**
The A.PROC (Audio processor) list display appears.
- 4 **Turn the Rotary encoder to select "PRESET MEMORY."**
The Function Guide changes.
- 5 **Press one of [1] (P.SET1) to [6] (P.SET6) for more than 2 seconds.**
The setting contents are stored.

- *The stored contents will not be deleted even when the battery power cord is detached.*

Getting out the Preset Memory

- 1 **Check that Defeat mode is off.**
- 2 **Press SOURCE/POWER.**
The main menu is displayed.
- 3 **Press [4] (A.PROC).**
The A.PROC (Audio processor) list display appears.
- 4 **Turn the Rotary encoder to select "PRESET MEMORY."**
The Function Guide changes.
- 5 **Press one of [1] (P.SET1) to [6] (P.SET6) to select the preset memory you want to get out.**

- *It takes a few moment to get out the preset memory.*

Using the ProLogic II Mode

Pro Logic processing can be conducted on the music signals recorded on two channels to achieve Dolby Pro Logic II surround sound. For two-channel Dolby Digital and DTS signals, there is also a "REAR FILL" function for outputting the signals of the front channel to the rear channel.

- 1 Check that Defeat mode is off.**
- 2 Press SOURCE/POWER.**
The main menu is displayed.
- 3 Press [4] (A.PROC).**
The A.PROC (Audio processor) list display appears.
- 4 Turn the Rotary encoder to select "DOLBY PL II."**
The Function Guide changes.
- 5 Press [1] (SETUP).**
The DOLBY PL II adjustment display appears.
- 6 Turn the Rotary encoder to select DOLBY PL II.**
- 7 Press the function button to select your desired mode.**

PL II MOVIE:

Suits the stereo TV shows and all programs encoded in Dolby Surround. It improves the sound field directivity to near that of discrete 5.1-channel sound.

PL II MUSIC:

Can be used for all stereo music recordings, and provides a wide, deep sound field.

REAR FILL:

Depending on the input signals, the sound may only be output from the front speakers. In this case, the "REAR FILL" function can be used to output signals from the rear speakers as well.

OFF: Turns DOLBY PL II function to OFF.

If PL II MUSIC is selected, the center width can be adjusted with following operations.

This function offers the optimum vocal position by adjusting the center channel position between the center speaker and the L/R speaker. (The adjustments established in "Adjusting the acoustic image" (page 49) are ineffective while this function is activated.)

- 1 Turn the **Rotary encoder** to select CENTER WIDTH CONT.
The Function Guide changes.
 - 2 Press [2] (ON).
By pressing [1] (OFF), the CENTER WIDTH CONT function is turned to OFF.
 - 3 Press [3] (LEVEL ◀DN) or [4] (LEVEL UP ▶) to adjust the level.
The level can be adjusted between 0 to 7. When the level increases, the center channel position moves from the center speaker position to both sides.
- *This adjustment is effective when the setting of the center speaker is SMALL or LARGE in the speaker setup settings.*

- *Avoid stopping, pausing, switching the disc, cueing, fast-forwarding or switching the audio channel of this unit while making this adjustment. The setting is canceled if the Decode mode is switched.*
- *This adjustment is ineffective when the speaker is set to CENTER OFF in "Setting the Speaker" (page 45).*
- *This function only works with two-channel signals. This operation is ineffective when 5.1-channel DTS or Dolby Digital signals are input.*
- *If the setting of REAR FILL is made when REAR MIX is ON, sound is unchanged in the rear fill setting because REAR MIX is given priority during 2 channel decoder other than linear PCM.*
- *For linear PCM signals, the voice is output from the rear speaker regardless of the REAR FILL and REAR MIX setting.*

Linear PCM Setting

The output when playing discs recorded in linear PCM can be set to 2 or 3 channels.

- 1 Check that Defeat mode is off.**
 - 2 Press SOURCE/POWER.**
The main menu is displayed.
 - 3 Press [4] (A.PROC).**
A.PROC (Audio processor) list display appears.
 - 4 Turn the Rotary encoder to select "PCM MODE".**
The Function Guide changes.
 - 5 Press [1] (2CH) or [2] (3CH).**
2CH: 2ch output (L/R)
3CH: 3ch output (L/R/CENTER)
- *This adjustment is ineffective when the speaker is set to CENTER OFF in "Setting the Speaker" (page 45).*

Remote Control

Operating for the IVA-D900

Set the mode selector switch to "AUDIO" to perform operations on the IVA-D900.

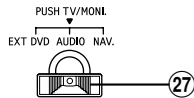
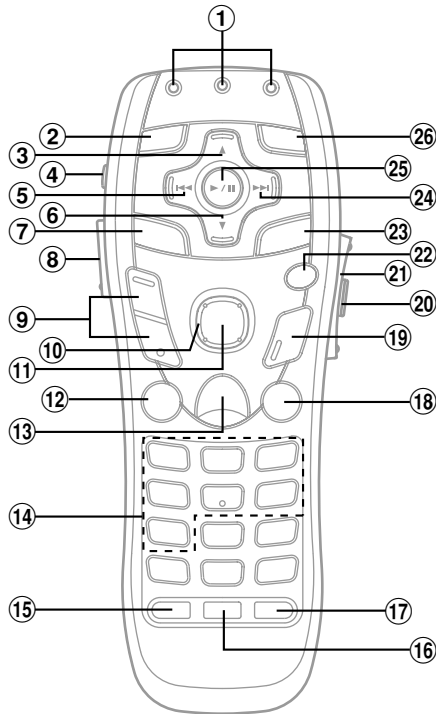

(Rear of the Remote Control)

- ① **AUDIO/NAV/EXT DVD Transmission Indicator**
When the mode selector switch is switched, the transmission indicators for the various modes light for several seconds.
- ② **A.PROC Button**
Press the button to call the audio processor list.
- ③ **▲ Button**
Radio mode: Selects, in ascending order, stations programmed into the radio's presets.
MP3 mode: Folder Select (UP) Button to selects the folder.
CD Changer mode: DISC Select (UP) Button selects a disc in ascending order.
- ④ **POWER Button**
Turns the power on/off.
- ⑤ **◀◀ Button**
Radio mode: SEEK (DN) Button
CD/Changer mode: Press the button to go back to the beginning of the current track. Press and hold to fast reverse.
MP3 mode: Press the button to go back to the beginning of the current file.
DVD/Video CD: Move to the desired position on the disc. During playback, press and hold for more than 1 second to reverse the disc at double speed. Hold for more than 5 seconds to reverse the disc at 8 times the normal speed.
- ⑥ **▼ Button**
Radio mode: Selects, in descending order, stations programmed into the radio's presets.
MP3 mode: Folder Select (DN) Button selects the folder.
CD Changer mode: DISC Select (DN) Button selects a disc in descending order.
- ⑦ **V.SEL Button**
Switches the screen when the unit is used in combination with a separately sold monitor, etc. (Simul function)
By pressing the button for more than 2 seconds, Simul function is canceled.
- ⑧ **LIGHT Button**
Lights the indicator.
- ⑨ **VOLUME ^ / ∨ Button**
Increase or decreases the volume level.
- ⑩ **Joystick**
Selects an item displayed in the screen.
- ⑪ **ENTER Button**
Enters the selected item.
- ⑫ **MUTE Button**
Lowers the volume by 20 dB instantly. Press the button again to cancel.
By pressing the button for more than 2 seconds, the monitor opens or closes.

- ⑬ **MENU/SETUP Button**
 DVD mode: Shows the menu display.
 Video CD mode:
 Turns PBC ON or OFF. (for Video CD with PBC functions)
 By pressing it more than 2 seconds, Setup list display appears.
- ⑭ **Numeric Keypad**
 The functions displayed in the Function Guide of the main menu are assigned to 1 to 7 buttons.
- ⑮ **AUDIO Button**
 DVD mode: Switches audio.
- ⑯ **SUB T. Button**
 DVD mode: Switches the subtitle.
- ⑰ **ANGLE Button**
 DVD mode: Switches the angle of the picture.
- ⑱ **RTN Button**
 DVD/Video CD (PBC ON) mode: Returns to the previous display. (Does not return in some discs.)
- ⑲ **DISP/TOP.M Button**
 DVD/Video CD mode:
 Shows playback status.
 DVD mode: By pressing more than 2 seconds, shows the menu display.
- ⑳ **REAR Button**
 Point the remote control to the remote control sensor of the IVA-D900, and press and hold for at least 2 seconds to switch the remote control sensor.
 To switch to the other remote control sensor, press REAR pointing to the remote control sensor of the currently selected external product.
- ㉑ **TILT \wedge / \vee Button**
 Adjusts the angle of the movable audio display.
 The angle moves continuously by keeping it pressed.
- ㉒ **■ Button**
 Performs stop.
- ㉓ **SOURCE Button**
 Selects the audio source.
- ㉔ **▶▶ Button**
 Radio mode: SEEK (UP) Button
 CD changer mode:
 Press the button to advance to the beginning of the next track. Press and hold to fast forward.
 MP3 mode: Press the button to advance to the beginning of the next file.
 DVD/Video CD:
 • Move to the desired position on the disc.
 • During playback, press and hold for more than 1 second to forward the disc at double speed. Hold for more than 5 seconds to forward the disc at 8 times the normal speed.
 • When pressed and held in while in the pause mode, the disc is played in slow motion at 1/8th the normal speed. When held in for 5 more seconds, the slow motion speed switches to 1/2 the normal speed.
 • The picture is forwarded by one frame each time the button is pressed in the pause mode.
- ㉕ **▶|| Button**
 Radio mode: Chooses the tuning mode.
 By pressing it more than 2 seconds, Automatic Memory will be operated.
 Disc mode: Switches between play and pause.
- ㉖ **BAND Button**
 Radio mode: Changes the band.
 CD/Changer mode:
 Switches the disc mode.
- ㉗ **MODE Change Switch**
 Sets to "AUDIO" to operate the IVA-D900.
 Sets to "EXT DVD" to operate a separately sold DVD product.
 Sets to "NAV." to operate a separately sold navigation product.
 When pressed, the mode switches to the TV mode.
 Operate while the transmission indicator is flashing.

Operating the DVD player/DVD changer (sold separately)

Set the mode selector switch to the "EXT DVD" side to operate a separately sold DVD player or DVD changer.

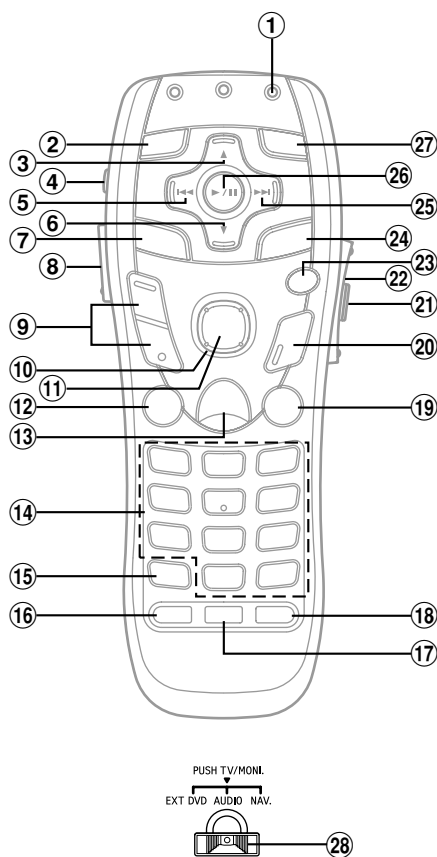

(Rear of the Remote Control)

- ① **EXT DVD Transmission Indicator**
If the mode switch is switched to the EXT DVD side, the transmission indicator flashes for few seconds.
- ② **A.PROC Button**
Calls the external audio processor mode.
- ③ **▲ Button**
Disc no. up (Only for DVD changer)
- ④ **POWER Button**
Press and hold for at least 5 seconds to switch the NTSC/PAL.
- ⑤ **◀◀ Button**
Starts playback from the beginning of the current chapter or track.
Press and hold for at least 2 seconds to fast-reverse the chapter or track.
- ⑥ **▼ Button**
Disc no. down (Only for DVD changer)
- ⑦ **V.SEL Button**
Switches the screen of TV or DVD video.
- ⑧ **LIGHT Button**
Lights the indicator.
- ⑨ **VOLUME ▲ / ▼ Button**
Adjusts the volume of the IVA-D900.
- ⑩ **Joystick**
Selects the item displayed on the screen.
- ⑪ **ENTER Button**
Decides the selected item.
- ⑫ **MUTE Button**
Decreases the volume of IVA-D900 instantly. Press the button again to cancel.
- ⑬ **MENU/SETUP Button**
Displays the DVD menu.
Press and hold for at least 2 seconds to access SETUP (initial setting).
- ⑭ **Numeric Keypad**
Inputs numbers
- ⑮ **DEL. Button**
Deletes one digit of the selected/inputted numbers. Press and hold for at least 2 seconds to delete all of the selected/inputted numbers.
- ⑯ **AUDIO Button**
Switches the audio tracks.
- ⑰ **SUB T. Button**
Switches the subtitle.
Press and hold for at least 2 seconds to turn ON/OFF the subtitle display.
- ⑱ **ANGLE Button**
Switches the angle.
- ⑲ **RTN Button**
Returns to the previous selection screen.
- ⑳ **DISP/TOP.M Button**
Starts playback from the beginning of chapter/track/elapsed time.
Press and hold for at least 2 seconds to display the title menu.
- ㉑ **REAR Button**
The same operation with the REAR button can be performed on the supplied remote control V.OUT button of the DVD player or DVD changer. Refer to a supplementary note with an asterisk in step 3 in "Switching the Visual Source Only (Simul Function)" on page 27.
- ㉒ **TILT ▲ / ▼ Button**
Changes the audio display angle.
- ㉓ **■ Button**
Performs PRE STOP. Press again to cancel PRE STOP and stop the playback.
- ㉔ **SOURCE Button**
Selects the audio source.
- ㉕ **▶▶ Button**
Starts playback from the beginning of the following chapter or track.
Press and hold for at least 2 seconds to fast forward the chapter or track.

- ⑫ **▶/⏮ Button**
Performs playback.
Press and hold for at least 2 seconds for slow motion playback.
- ⑬ **BAND Button**
Switches the band of Audio or Disc mode.
- ⑭ **MODE Change Switch**
When operating the connected DVD player/DVD changer, switch to the EXT DVD side.
 - Depending on the disc or playback status, certain operations may not work. In this case, the ⓪ mark is displayed on the monitor screen.

- ① **NAV. transmission indicator**
The transmission indicator lights for a few seconds when the mode selector switch is set to "NAV."
- ② **DTR (DETOUR) Button**
Automatically recalculates route if a road block or traffic congestion is encountered.
- ③ **LIST Button**
Displays list of the streets currently set for the route. To return to the guidance mode, press the DISP button.
- ④ **DEL. DEST. Button**
Deletes current destination.
- ⑤ **OK button**
Executes numeral input and starts searching.
- ⑥ **N/H Button**
Toggles between North UP and Heading UP orientation.
- ⑦ **CANC. Button**
Cancels current display screen and switches back to previous screen with menus.
- ⑧ **SCALE UP/DN Buttons**
- ⑨ **VOICE Button**
Initiates vocal instruction for next route maneuver or repeats last instruction.
- ⑩ **MODE Button**
Inputs numerals using the numeric keypad, DEL. and +10 buttons.
After pressing the MODE button, the following buttons will be pressed while the status indicator is blinking: numerals (0-9), DEL. and +10.
- ⑪ **MODE Change Switch**
Sets this switch to the "NAV." side to operate a connected Alpine navigation system.

Operating the Navigation (sold separately)

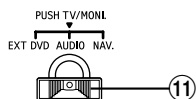
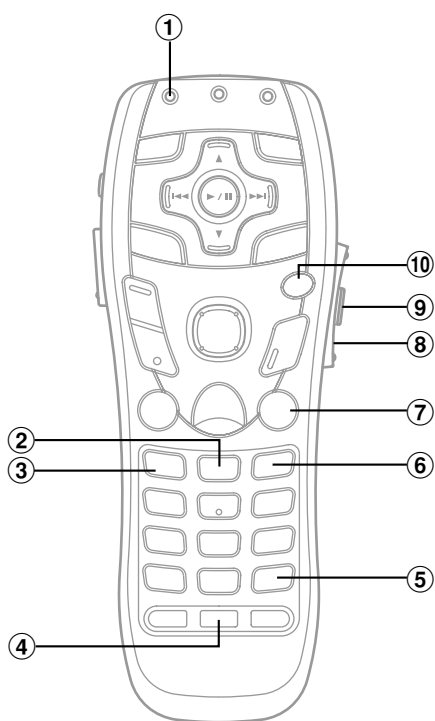

(Rear of the Remote Control)

Operating a separately sold TV monitor

- To operate a separately sold Alpine TV monitor, press the mode change switch on the rear of the remote control unit. Operate while the transmission indicator is blinking.
- Included remote control unit operation seal: Apply the seal for the type of TV monitor you are using to the rear of the remote control unit.
 - Operation may differ or may not be possible for some products. Also refer to the product's operating instructions.

Battery Replacement

Applicable battery: Use two “AAA” sized dry batteries or equivalent.

1 Opening the battery cover.

Push on the cover and slide it as indicated by the arrows then the cover will be removed.

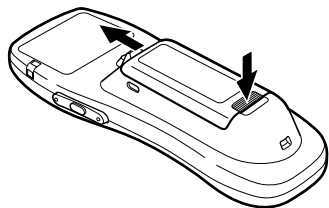

2 Replacing the battery.

Put the batteries in the case observing the polarity, as illustrated.

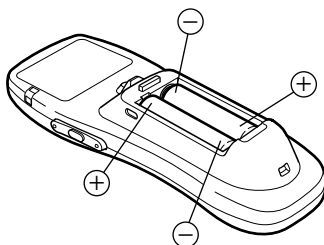

3 Closing the cover.

Push the cover in the arrow direction until a click is heard.

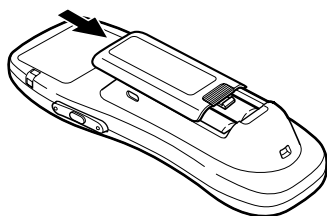

Notes on Using the Remote Control

Point the remote control transmitter at the remote control sensor.

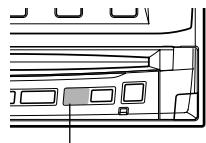

Remote control sensor

- Point the remote control at the remote sensor within about 2 meters.
- It may not be possible to operate the remote control unit if the remote control sensor is exposed to direct sunlight.
- The remote control is a small, light weight precision device. To avoid damage, short battery life, operational errors and poor button response, observe the following.
 - Do not subject to shock.
 - Do not put in a trouser pocket.
 - Keep away from food, moisture and dirt.
 - Do not place in direct sunlight.

Warning

DO NOT OPERATE ANY FUNCTION THAT TAKES YOUR ATTENTION AWAY FROM SAFELY DRIVING YOUR VEHICLE.

Any function that requires your prolonged attention should only be performed after coming to a complete stop. Always stop the vehicle in a safe location before performing these functions. Failure to do so may result in an accident.

Information

About DVDs

Music CDs and DVDs have grooves (tracks) in which the digital data is recorded. The data is represented as microscopic pits recorded into the track – these pits are read by a laser beam to play the disc. On DVDs, the density of the tracks and pits is twice that of CDs, so DVDs can contain more data in less space.

CDs

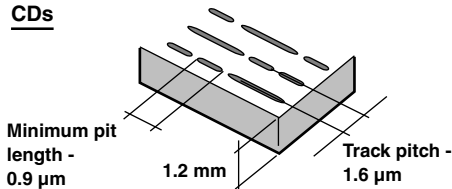

DVDs

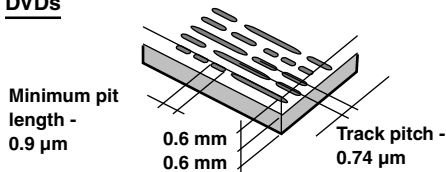

A 12 cm disc can contain one movie or about four hours of music.

In addition, DVDs provide sharp picture quality with vivid colors thanks to a horizontal resolution of over 500 lines (compared to less than 300 for VHS tape). With the addition of an optional, digital audio processor (PXA-H900/PXA-H510/PXA-H700), you can recreate the power and presence of a movie theater with Dolby Digital 5.1-channel Surround.

In addition, DVDs offer a variety of functions.

- **Multiple audio*** (page 18)

Movies can be recorded in up to eight languages. The desired language can be selected from the remote control unit.

- **Subtitles function*** (page 19)

Movies can include subtitles in up to 32 languages. The desired subtitle language can be selected from the remote control unit.

- **Multi angle function*** (page 18)

When the DVD contains a movie shot from multiple angles, the desired angle can be selected from the remote control unit.

- **Multi story function***

With this function, a single movie includes various story lines. You can select different story lines to view various versions of the same movie.

Operation differs from disc to disc. Story line selection screens including instructions appear during the movie. Just follow the instructions.

* *The functions audio languages, subtitle languages, angles, etc., differ from disc to disc. For details, refer to the disc's instructions.*

Terminology

Dolby Digital

Dolby Digital is a digital audio compression technology developed by Dolby Laboratories that allows large quantities of audio data to be efficiently recorded on discs. It is compatible with audio signals from mono (1 channel) all the way up to 5.1-channel surround sound. The signals for the different channels are completely independent, and since the sound is high quality digital there is no loss of sound quality.

* *The separately sold digital audio processor (PXA-H510/PXA-H900/PXA-H700) is required to enjoy full 5.1-channel surround sound.*

The IVA-D900 performs Dolby Digital decoding when it outputs analog audio signals, it just happens to be 2-channel audio not 5.1-channel.

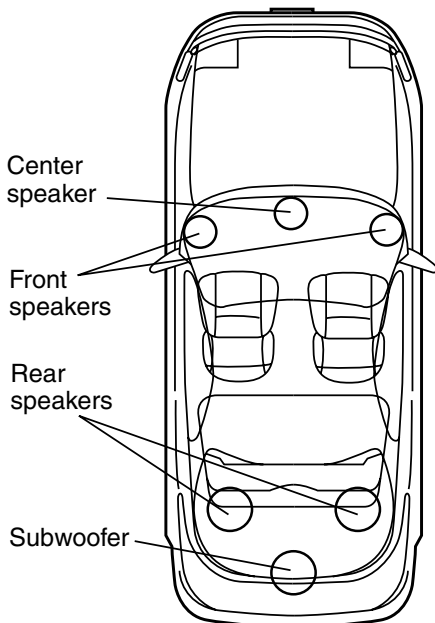

Speaker layout for enjoying Dolby Digital sound/dts sound

DTS

This is a home-use digital sound format of the DTS Sound System. This is a high quality sound system, developed by Digital Theater Systems Corp. for use in movie theaters. DTS has six independent sound tracks. The theater presentation is fully realized in the home and other settings. DTS is the abbreviation for Digital Theater System.

* *To enjoy DTS surround sound you need the separately sold DTS digital audio processor (PXA-H900/PXA-H700). The DVD video software must also have a DTS sound track.*

The IVA-D900 has a built-in DTS 2-channel audio decoder. Analog audio outputs are available.

Dolby Pro Logic

Dolby Pro Logic is the technology used to decode programs encoded in Dolby Surround. Pro logic decoding will provide you with four channels of sound (front left/right, center and monaural rear surround) from a 2-channel (stereo) source.

* *The separately sold digital audio processor (PXA-H510/PXA-H900) is required to enjoy Dolby Pro Logic surround sound.*

Dolby Pro Logic II

Dolby Pro Logic II plays 2-channel sources in 5 channels over the entire frequency range.

This is done with an advance, high sound quality matrix surround decoder which draws out the spatial properties of the original recording without adding any sounds to or changing the sound of the source.

* *The separately sold digital audio processor (PXA-H700) is required to enjoy Dolby Pro Logic II surround sound.*

Linear PCM audio (LPCM)

LPCM is a signal recording format used for music CDs. Whereas music CDs are recorded at 44.1 kHz/16 bits, DVDs are recorded at 48 kHz/16 bits to 96 kHz/24 bits, thereby achieving higher sound quality than music CDs.

Rating levels (parental lock)

This is a function of the DVD for restricting the viewing age as stipulated by laws in different countries. The way in which viewing is restricted differs from DVD to DVD. Sometimes the DVD cannot be played at all, other times certain scenes are skipped, and other times certain scenes are replaced with other scenes.

List of Language Codes

(For details, see page 29.)

| Abbreviation | Code | Language | Abbreviation | Code | Language | Abbreviation | Code | Language |
|--------------|------|-----------------|--------------|------|------------------|--------------|------|----------------|
| AA | 6565 | Afar | IE | 7369 | Interlingue | RN | 8278 | Kirundi |
| AB | 6566 | Abkhazian | IK | 7375 | Inupiak | RO | 8279 | Romanian |
| AF | 6570 | Afrikaans | IN | 7378 | Indonesian | RU | 8285 | Russian |
| AM | 6577 | Amharic | IS | 7383 | Icelandic | RW | 8287 | Kinyarwanda |
| AR | 6582 | Arabic | IT | 7384 | Italian | SA | 8365 | Sanskrit |
| AS | 6583 | Assamese | IW | 7387 | Hebrew | SD | 8368 | Sindhi |
| AY | 6589 | Aymara | JA | 7465 | Japanese | SG | 8371 | Sangho |
| AZ | 6590 | Azerbaijani | JI | 7473 | Yiddish | SH | 8372 | Serbo-Croatian |
| BA | 6665 | Bashkir | JW | 7487 | Javanese | SI | 8373 | Singhalese |
| BE | 6669 | Byelorussian | KA | 7565 | Georgian | SK | 8375 | Slovak |
| BG | 6671 | Bulgarian | KK | 7575 | Kazakh | SL | 8376 | Slovenian |
| BH | 6672 | Bihari | KL | 7576 | Greenlandic | SM | 8377 | Samoa |
| BI | 6673 | Bislama | KM | 7577 | Cambodian | SN | 8378 | Shona |
| BN | 6678 | Bengali, Bangla | KN | 7578 | Kannada | SO | 8379 | Somali |
| BO | 6679 | Tibetan | KO | 7579 | Korean | SQ | 8381 | Albanian |
| BR | 6682 | Breton | KS | 7583 | Kashmiri | SR | 8382 | Serbian |
| CA | 6765 | Catalan | KU | 7585 | Kurdish | SS | 8383 | Siswati |
| CO | 6779 | Corsican | KY | 7589 | Kirghiz | ST | 8384 | Sesotho |
| CS | 6783 | Czech | LA | 7665 | Latin | SU | 8385 | Sundanese |
| CY | 6789 | Welsh | LN | 7678 | Lingala | SV | 8386 | Swedish |
| DA | 6865 | Danish | LO | 7679 | Laothian | SW | 8387 | Swahili |
| DE | 6869 | German | LT | 7684 | Lithuanian | TA | 8465 | Tamil |
| DZ | 6890 | Bhutani | LV | 7686 | Latvian, Lettish | TE | 8469 | Telugu |
| EL | 6976 | Greek | MG | 7771 | Malagasy | TG | 8471 | Tajik |
| EN | 6978 | English | MI | 7773 | Maori | TH | 8472 | Thai |
| EO | 6979 | Esperanto | MK | 7775 | Macedonian | TI | 8473 | Tigrinya |
| ES | 6983 | Spanish | ML | 7776 | Malayalam | TK | 8475 | Turkmen |
| ET | 6984 | Estonian | MN | 7778 | Mongolian | TL | 8476 | Tagalog |
| EU | 6985 | Basque | MO | 7779 | Moldavian | TN | 8478 | Setswana |
| FA | 7065 | Persian | MR | 7782 | Marathi | TO | 8479 | Tonga |
| FI | 7073 | Finnish | MS | 7783 | Malay | TR | 8482 | Turkish |
| FJ | 7074 | Fiji | MT | 7784 | Maltese | TS | 8483 | Tsonga |
| FO | 7079 | Faroese | MY | 7789 | Burmese | TT | 8484 | Tatar |
| FR | 7082 | French | NA | 7865 | Nauru | TW | 8487 | Twi |
| FY | 7089 | Frisian | NE | 7869 | Nepali | UK | 8575 | Ukrainian |
| GA | 7165 | Irish | NL | 7876 | Dutch | UR | 8582 | Urdu |
| GD | 7168 | Scots Gaelic | NO | 7879 | Norwegian | UZ | 8590 | Uzbek |
| GL | 7176 | Galician | OC | 7967 | Occitan | VI | 8673 | Vietnamese |
| GN | 7178 | Guarani | OM | 7977 | (Afan) Oromo | VO | 8679 | Volapuk |
| GU | 7185 | Gujarati | OR | 7982 | Oriya | WO | 8779 | Wolof |
| HA | 7265 | Hausa | PA | 8065 | Punjabi | XH | 8872 | Xhosa |
| HI | 7273 | Hindi | PL | 8076 | Polish | YO | 8979 | Yoruba |
| HR | 7282 | Croatian | PS | 8083 | Pashto, Pushto | ZH | 9072 | Chinese |
| HU | 7285 | Hungarian | PT | 8084 | Portuguese | ZU | 9085 | Zulu |
| HY | 7289 | Armenian | QU | 8185 | Quechua | | | |
| IA | 7365 | Interlingua | RM | 8277 | Rhaeto-Romance | | | |

List of Country Codes

(For details, see page 29.)

| Abbreviation | Code | Country | Abbreviation | Code | Country | Abbreviation | Code | Country |
|--------------|------|---------------------------------------|--------------|------|--|--------------|------|--|
| AD | 6568 | Andorra | DM | 6877 | Dominica | KI | 7573 | Kiribati |
| AE | 6569 | United Arab Emirates | DO | 6879 | Dominican Republic | KM | 7577 | Comoros |
| AF | 6570 | Afghanistan | DZ | 6890 | Algeria | KN | 7578 | Saint Kitts and Nevis |
| AG | 6571 | Antigua and Barbuda | EC | 6967 | Ecuador | KP | 7580 | Korea, Democratic People's Republic of |
| AI | 6573 | Anguilla | EE | 6969 | Estonia | | | |
| AL | 6576 | Albania | EG | 6971 | Egypt | KR | 7582 | Korea, Republic of |
| AM | 6577 | Armenia | EH | 6972 | Western Sahara | KW | 7587 | Kuwait |
| AN | 6578 | Netherlands Antilles | ER | 6982 | Eritrea | KY | 7589 | Cayman Islands |
| AO | 6579 | Angola | ES | 6983 | Spain | KZ | 7590 | Kazakistan |
| AQ | 6581 | Antarctica | ET | 6984 | Ethiopia | LA | 7665 | Lao People's Democratic Republic |
| AR | 6582 | Argentina | FI | 7073 | Finland | | | |
| AS | 6583 | American Samoa | FJ | 7074 | Fiji | LB | 7666 | Lebanon |
| AT | 6584 | Austria | FK | 7075 | Falkland Islands | LC | 7667 | Saint Lucia |
| AU | 6585 | Australia | FM | 7077 | Micronesia, Federated States of | LI | 7673 | Liechtenstein |
| AW | 6587 | Aruba | FO | 7079 | Faroe Islands | LK | 7675 | Sri Lanka |
| AZ | 6590 | Azerbaijan | FR | 7082 | France | LR | 7682 | Liberia |
| BA | 6665 | Bosnia and Herzegovina | GA | 7165 | Gabon | LS | 7683 | Lesotho |
| BB | 6666 | Barbados | GB | 7166 | United Kingdom | LT | 7684 | Lithuania |
| BD | 6668 | Bangladesh | GD | 7168 | Grenada | LU | 7685 | Luxembourg |
| BE | 6669 | Belgium | GE | 7169 | Georgia | LV | 7686 | Latvia |
| BF | 6670 | Burkina Faso | GF | 7170 | French Guiana | LY | 7689 | Libyan Arab Jamahiriya |
| BG | 6671 | Bulgaria | GH | 7172 | Ghana | MA | 7765 | Morocco |
| BH | 6672 | Bahrain | GI | 7173 | Gibraltar | MC | 7767 | Monaco |
| BI | 6673 | Burundi | GL | 7176 | Greenland | MD | 7768 | Moldova, Republic of |
| BJ | 6674 | Benin | GM | 7177 | Gambia | MG | 7771 | Madagascar |
| BM | 6677 | Bermuda | GN | 7178 | Guinea | MH | 7772 | Marshall Islands |
| BN | 6678 | Brunei Darussalam | GP | 7180 | Guadeloupe | MK | 7775 | Macedonia, The former Yugoslav Republic of |
| BO | 6679 | Bolivia | GQ | 7181 | Equatorial Guinea | | | |
| BR | 6682 | Brazil | GR | 7182 | Greece | ML | 7776 | Mali |
| BS | 6683 | Bahamas | GS | 7183 | South Georgia and the South Sandwich Islands | MM | 7777 | Myanmar |
| BT | 6684 | Bhutan | | | | MN | 7778 | Mongolia |
| BV | 6686 | Bouvet Island | GT | 7184 | Guatemala | MO | 7779 | Macau |
| BW | 6687 | Botswana | GU | 7185 | Guam | MP | 7780 | Northern Mariana Islands |
| BY | 6689 | Belarus | GW | 7187 | Guinea-Bissau | MQ | 7781 | Martinique |
| BZ | 6690 | Belize | GY | 7189 | Guyana | MR | 7782 | Mauritania |
| CA | 6765 | Canada | HK | 7275 | Hong Kong | MS | 7783 | Montserrat |
| CC | 6767 | Cocos (Keeling) Islands | HM | 7277 | Heard Island and McDonald Islands | MT | 7784 | Malta |
| CD | 6768 | Congo, the Democratic Republic of the | HN | 7278 | Honduras | MU | 7785 | Mauritius |
| CF | 6770 | Central African Republic | HR | 7282 | Croatia | MV | 7786 | Maldives |
| CG | 6771 | Congo | HT | 7284 | Haiti | MW | 7787 | Malawi |
| CH | 6772 | Switzerland | HU | 7285 | Hungary | MX | 7788 | Mexico |
| CI | 6773 | Cote d'Ivoire | ID | 7368 | Indonesia | MY | 7789 | Malaysia |
| CK | 6775 | Cook Islands | IE | 7369 | Ireland | MZ | 7790 | Mozambique |
| CL | 6776 | Chile | IL | 7376 | Israel | NA | 7865 | Namibia |
| CM | 6777 | Cameroon | IN | 7378 | India | NC | 7867 | New Caledonia |
| CN | 6778 | China | IO | 7379 | British Indian Ocean Territory | NE | 7869 | Niger |
| CO | 6779 | Colombia | IQ | 7381 | Iraq | NF | 7870 | Norfolk Island |
| CR | 6782 | Costa Rica | IR | 7382 | Iran, Islamic Republic of | NG | 7871 | Nigeria |
| CU | 6785 | Cuba | IS | 7383 | Iceland | NI | 7873 | Nicaragua |
| CV | 6786 | Cape Verde | IT | 7384 | Italy | NL | 7876 | Netherlands |
| CX | 6788 | Christmas Island | JM | 7477 | Jamaica | NO | 7879 | Norway |
| CY | 6789 | Cyprus | JO | 7479 | Jordan | NP | 7880 | Nepal |
| CZ | 6790 | Czech Republic | JP | 7480 | Japan | NR | 7882 | Nauru |
| DE | 6869 | Germany | KE | 7569 | Kenya | NU | 7885 | Niue |
| DJ | 6874 | Djibouti | KG | 7571 | Kyrgyzstan | NZ | 7890 | New Zealand |
| DK | 6875 | Denmark | KH | 7572 | Cambodia | OM | 7977 | Oman |
| | | | | | | PA | 8065 | Panama |

| Abbreviation | Code | Country | Abbreviation | Code | Country | Abbreviation | Code | Country |
|--------------|------|---------------------------|--------------|------|-----------------------------|--------------|------|--------------------------------------|
| PE | 8069 | Peru | SJ | 8374 | Svalbard and Jan Mayen | TW | 8487 | Taiwan, Province of China |
| PF | 8070 | French Polynesia | SK | 8375 | Slovakia | TZ | 8490 | Tanzania, United Republic of |
| PG | 8071 | Papua New Guinea | SL | 8376 | Sierra Leone | UA | 8565 | Ukraine |
| PH | 8072 | Philippines | SM | 8377 | San Marino | UG | 8571 | Uganda |
| PK | 8075 | Pakistan | SN | 8378 | Senegal | UM | 8577 | United States Minor Outlying Islands |
| PL | 8076 | Poland | SO | 8379 | Somalia | US | 8583 | United States |
| PM | 8077 | Saint Pierre and Miquelon | SR | 8382 | Suriname | UY | 8589 | Uruguay |
| PN | 8078 | Pitcairn | ST | 8384 | Sao Tome and Principe | UZ | 8590 | Uzbekistan |
| PR | 8082 | Puerto Rico | SV | 8386 | El Salvador | VA | 8665 | Holy See (Vatican City State) |
| PT | 8084 | Portugal | SY | 8389 | Syrian Arab Republic | VC | 8667 | Saint Vincent and the Grenadines |
| PW | 8087 | Palau | SZ | 8390 | Swaziland | VE | 8669 | Venezuela |
| PY | 8089 | Paraguay | TC | 8467 | Turks and Caicos Islands | VG | 8671 | Virgin Island, British |
| QA | 8165 | Qatar | TD | 8468 | Chad | VI | 8673 | Virgin Islands, U.S. |
| RE | 8269 | Reunion | TF | 8470 | French Southern Territories | VN | 8678 | Viet Nam |
| RO | 8279 | Romania | TG | 8471 | Togo | VU | 8685 | Vanuatu |
| RU | 8285 | Russian Federation | TH | 8472 | Thailand | WF | 8770 | Wallis and Futuna |
| RW | 8287 | Rwanda | TJ | 8474 | Tajikistan | WS | 8783 | Samoa |
| SA | 8365 | Saudi Arabia | TK | 8475 | Tokelau | YE | 8969 | Yemen |
| SB | 8366 | Solomon Islands | TM | 8477 | Turkmenistan | YT | 8984 | Mayotte |
| SC | 8367 | Seychelles | TN | 8478 | Tunisia | YU | 8985 | Yugoslavia |
| SD | 8368 | Sudan | TO | 8479 | Tonga | ZA | 9065 | South Africa |
| SE | 8369 | Sweden | TP | 8480 | East Timor | ZM | 9077 | Zambia |
| SG | 8371 | Singapore | TR | 8482 | Turkey | ZW | 9087 | Zimbabwe |
| SH | 8372 | Saint Helena | TT | 8484 | Trinidad and Tobago | | | |
| SI | 8373 | Slovenia | TV | 8486 | Tuvalu | | | |

In Case of Difficulty

If you encounter a problem, please turn the power off, then on again. If the unit is still not functioning normally, please review the items in the following checklist. This guide will help you isolate the problem if the unit is at fault. Otherwise, make sure the rest of your system is properly connected, or then consult your authorized Alpine dealer.

Basic

No function or display.

- Vehicle's ignition is off.
 - If connected according to the instructions, the unit will not operate with the vehicle's ignition off.
- Improper power lead connections.
 - Check power lead connections.
- Blown fuse.
 - Check the fuse on the battery lead of the unit; replace with the proper value if necessary.
- Internal micro-computer malfunctioned due to interference noise, etc.
 - Press the RESET switch with a ballpoint pen or other pointed article.

No sound or unnatural sound.

- Incorrect setting of volume/balance/fader controls.
 - Readjust the controls.
- Connections are not properly or securely made.
 - Check the connections and firmly connect.

Screen not displayed.

- Brightness control is set at the minimum position.
 - Adjust the Brightness control.
- Temperature in the vehicle is too low.
 - Increase the vehicle's interior temperature to operation temperature range.
- Connections to the DVD, CD player, navigation system are not securely made.
 - Check the connections and firmly connect.

Movement of displayed picture is abnormal.

- Temperature in the vehicle is too high.
 - Allow the vehicle's interior temperature to cool.

Unclear or noisy display.

- Fluorescent plate is worn out.
 - Replace the fluorescent plate.

Navigation system inoperative.

- Connections to the navigation system are incorrect.
 - Check the connections with the navigation system and connect the cables correctly and firmly.

Unclear picture display.

- Fluorescent tube is exhausted.
 - Replace the fluorescent tube*.

* The fluorescent tube replacement is not free of charge even within the warranty period, for the tube is an article of consumption.

Radio

Unable to receive stations.

- No antenna, or open connection in the antenna cable.
 - Make sure the antenna is properly connected; replace the antenna or cable if necessary.

Unable to tune stations in the seek mode.

- You are in a weak signal area.
 - Make sure the tuner is in DX mode.
- If the area you are in is a primary signal area, the antenna may not be grounded and connected properly.
 - Check your antenna connections; make sure the antenna is properly grounded at its mounting location.
- The antenna may not be the proper length.
 - Make sure the antenna is fully extended; if broken, replace the antenna with a new one.

Broadcast is noisy.

- The antenna is not the proper length.
 - Extend the antenna fully; replace it if it is broken.
- The antenna is poorly grounded.
 - Make sure the antenna is grounded properly at its mounting location.
- The station signal is weak and noisy.
 - If above solution does not work, tune in another station.

CD/MP3/DVD/Video CD

Disc playback sound is wavering.

- Moisture condensation in the disc Module.
 - Allow enough time for the condensation to evaporate (about 1 hour).

Disc insertion not possible.

- A disc is already in the DVD player.
 - Eject the disc and remove it.
- The disc is being improperly inserted.
 - Make sure the disc is being inserted following the instructions in the CD (MP3/DVD/Video CD) Player Operation section.

Unable to fast forward or backward the disc.

- The disc has been damaged.
 - Eject the disc and discard it; using a damaged disc in your unit can cause damage to the mechanism.

Disc playback sound skips due to vibration.

- Improper mounting of the unit.
 - Securely re-mount the unit.
- Disc is very dirty.
 - Clean the disc.
- Disc has scratches.
 - Change the disc.
- The pick-up lens is dirty.
 - Do not use a commercial available lens cleaner disc. Consult your nearest ALPINE dealer.

Disc playback sound skips without vibration.

- Dirty or scratched disc.
 - Clean the disc; damaged disc should be replaced.

CD-R/CD-RW playback not possible.

- Close session (finalization) has not been performed.
 - Perform finalization and attempt playback again.

Error displays

- Mechanical error
 - Press ▲. After the error indication disappears, insert the disc again. If the above-mentioned solution does not solve the problem, consult your nearest ALPINE dealer.

MP3 is not played back.

- Writing error occurred. The CD format is not compatible.
 - Make sure the CD has been written in a supported format. Refer to "About MP3" (pages 13 and 14), then rewrite in the format supported by this device.

Unit does operate.

- Monitor's power is not turned on.
 - Turn on the monitor's power.
- Condensation.
 - Wait a while (about 1 hour) for the condensation to dry.

No picture is produced.

- Monitor's mode is not switched to the mode you want to see.
 - Switch to the mode you want to see.
- Monitor's parking brake lead is not connected.
 - Connect the monitor's parking brake lead and set the parking brake.
(For details, refer to the monitor's instructions.)
- Monitor's parking brake is not set.
 - Connect the monitor's parking brake lead and set the parking brake.
(For details, refer to the monitor's instructions.)

Playback does not start.

- Disc is loaded upside-down.
 - Check the disc and load it with the labeled side facing upward.
- Disc is dirty.
 - Clean the disc.
- A disc not able to playback with this unit is loaded.
 - Check if the disc is able to be played back.
- Parental lock is set.
 - Cancel the parental lock or change the rating level.

Picture is unclear or noisy.

- Disc is being fast-forwarded or fast-reversed.
 - The picture may be slightly disturbed, but this is normal.
- Vehicle's battery power is weak.
 - Check the battery power and wiring.
(The unit may malfunction if the battery power is under 11 volts with a load applied.)
- Monitor's fluorescent tube is worn.
 - Replace the monitor's fluorescent tube.

Image stops sometimes.

- Disc is scratched.
 - Replaced with a non-scratched disc.

Indication for CD/MP3

HI-TEMP

- Protective circuit is activated due to high temperature.
 - The indicator will disappear when the temperature returns to within operation range.
 - Leave the power OFF until the temperature decreases and then turn the power ON again.

NO DISC

- No disc is inserted.
 - Insert a disc.
- Although a disc is inserted, "NO DISC" is displayed and the unit does not start to play or eject the disc.
 - Remove the disc by following these steps:
Press ▲ for at least 3 seconds.

Continued

Indication for DVD/Video CD

NO DISC

(Displayed only in IVA-D900 (front monitor))

- No disc is inserted.
 - Insert a disc.
 - Although a disc is inserted, "NO DISC" is displayed and the unit does not start to play or eject the disc.
 - Remove the disc by following these steps:
 - Press ▲ for at least 3 seconds.
-



- Remote control operation is not possible.
 - For some discs or playing modes, certain operations are not possible. This is not a malfunction.
-

HI-TEMP

- Protective circuit is activated to high temperature.
 - The indicator will disappear when the temperature returns to within operation range.
 - Leave the power OFF until the temperature decreases and then turn the power ON again.
-

VIDEO SIGNAL SYSTEM IS NOT CORRECT

- PAL disc is loaded.
 - Load an NTSC disc

LOADING ERROR

(Displayed in the rear monitor)

EJECT ERROR

(Displayed in the rear monitor)

- Mechanism error.
 - 1) Press ▲ and eject the disc.
 - If not ejecting, consult your Alpine dealer.
 - 2) When the error indication remains after ejecting, press ▲ again.
 - If the error indication still does not turn off after pressing ▲ for a few times, consult your Alpine dealer.
-

DISC ERROR

(Displayed in the rear monitor)

- Scratched disc, contaminated disc/poor recording/disc incompatible with this unit
 - Press ▲.
 - Change the disc.
-

Indication for CD changer

HI-TEMP

- Protective circuit is activated due to high temperature.
 - The indicator will disappear when the temperature returns to within operation range.

ERROR - 01

- Malfunction in the CD Changer.
 - Consult your Alpine dealer. Press the magazine eject button and pull out the magazine. Check the indication. Insert the magazine again. If the magazine cannot be pulled out, consult your Alpine dealer.
- Magazine ejection not possible.
 - Press the magazine eject button. If the magazine does not eject, consult your Alpine dealer.

ERROR - 02

- A disc is left inside the CD Changer.
 - Press the Eject button to activate the eject function. When the CD Changer finishes the eject function, insert an empty CD magazine into the CD Changer to receive the disc left inside the CD Changer.

NO MAGZINE

- No magazine is loaded into the CD Changer.
 - Insert a magazine.

NO DISC

- No indicated disc.
 - Choose another disc.

Indication for XM radio mode

ANTENNA

- The XM antenna is not connected to the XM radio module.
 - Check whether the XM antenna cable is attached securely to the XM radio module.

UPDATING

- Radio is being updated with latest encryption code.
 - Wait until encryption code is being updated. Channels 0 and 1 should function normally.

NO SIGNAL

- XM signal is too weak at the current location.
 - Wait until the car reaches a location with a stronger signal.

LOADING

- Radio is acquiring audio or program information.
 - Wait until the radio has received the information.

OFF AIR

- The channel currently selected has stopped broadcasting.
 - Select another channel.

- The user has selected a Channel Number that does not exist or is not subscribed to.
 - The unit will revert back to the previously selected channel.
- There is no artist name/feature, song/program title, or additional information associated with the channel at that time.
 - No action needed.

Specifications

MONITOR SECTION

| | |
|--------------------------------------|--|
| Screen Size | 7.0" |
| LCD Type | Transparent type TN LCD |
| Operation System | Low-Temperature p-si TFT active matrix |
| Number of Picture Elements | 1,152,000 pcs. (2,400 × 480) |
| Effective Number of Picture Elements | 99.99% or more |
| Illumination System | Cold cathode fluorescent tube |

FM TUNER SECTION

| | |
|-------------------------------|--------------------------------|
| Tuning Range | 87.7 – 107.9 MHz |
| Mono Usable Sensitivity | 9.3 dBf (0.8 μ V/75 ohms) |
| 50 dB Quieting Sensitivity | 13.5 dBf (1.3 μ V/75 ohms) |
| Alternate Channel Selectivity | 80 dB |
| Signal-to-Noise Ratio | 80 dB |
| Stereo Separation | 45 dB |
| Capture Ratio | 2.0 dB |

AM TUNER SECTION

| | |
|--------------------|----------------------|
| Tuning Range | 530 – 1,710 kHz |
| Usable Sensitivity | 22.5 μ V/27.0 dB |

CD/DVD SECTION

| | |
|---------------------------|-------------------------|
| Frequency Response | 5 – 20,000 Hz |
| Wow & Flutter (% WRMS) | Below measurable limits |
| Total Harmonic Distortion | 0.008% (at 1 kHz) |
| Dynamic Range | 95 dB (at 1 kHz) |
| Channel Separation | 90 dB (at 1 kHz) |
| Signal system | NTSC |
| Horizontal resolution | 500 lines or greater |
| Video output level | 1Vp-p (75 ohms) |
| Video S/N ratio | DVD: 70 dB |
| Audio S/N ratio | More than 115 dB |

PICKUP

| | |
|-------------|----------|
| Wave length | 668 nm |
| Laser power | CLASS II |

REMOTE CONTROL

| | |
|--------------|------------------------|
| Battery Type | AAA batteries (2 pcs.) |
| Width | 56 mm (2-1/4") |
| Height | 142.5 mm (5-5/8") |
| Depth | 37 mm (1-7/16") |
| Weight | 72 g (2.54 oz) |

GENERAL

| | |
|----------------------------|---|
| Power Requirement | 14.4 V DC (11–16 V allowable) |
| Operating temperature | +32°F to +113°F (0°C to +45°C) |
| Maximum Power Output | 50 W × 4 |
| Output Voltage | 2,000 mV/10k ohms |
| Maximum Pre-Output Voltage | 4 V/10k ohms |
| Bass | ±14 dB at 30 Hz |
| Treble | ±14 dB at 10 kHz |
| Weight | (Monitor Section) 1.7 kg (3 lbs. 12 oz) (Tuner Section) 1.6 kg (3 lbs. 8 oz) |
| Audio output level | |
| Preout (Front, Rear): | 4V/10k ohms (max.) |
| Preout (Subwoofer): | 4V/10k ohms (max.) |
| Auxout: | 1.2V/10k ohms |
| Ai-NET: | 850 mV |

CHASSIS SIZE (Monitor section)

| | |
|--------|-----------------|
| Width | 178 mm (7") |
| Height | 50 mm (2") |
| Depth | 165 mm (6-1/2") |

CHASSIS SIZE (Tuner section)

| | |
|--------|--------------------|
| Width | 275 mm (10-53/64") |
| Height | 40 mm (1-37/64") |
| Depth | 170 mm (6-11/16") |

- Due to continuous product improvement, specifications and design are subject to change without notice.
- The LCD panel is manufactured using an extremely high precision manufacturing technology. Its effective pixel ratio is over 99.99%. This means that there is a possibility that 0.01% of the pixels could be either always ON or OFF.

CAUTION

CAUTION-Laser radiation when open, DO NOT STARE INTO BEAM

(Bottom side of Monitor player)

Installation and Connections

Before installing or connecting the unit, please read the following and pages 4 to 6 of this manual thoroughly for proper use.

Warning

MAKE THE CORRECT CONNECTIONS

Failure to make the proper connections may result in fire or product damage.

USE ONLY IN CARS WITH A 12 VOLT NEGATIVE GROUND.

(Check with your dealer if you are not sure.) Failure to do so may result in fire, etc.

BEFORE WIRING, DISCONNECT THE CABLE FROM THE NEGATIVE BATTERY TERMINAL.

Failure to do so may result in electric shock or injury due to electrical shorts.

DO NOT ALLOW CABLES TO BECOME ENTANGLED IN SURROUNDING OBJECTS.

Arrange wiring and cables in compliance with the manual to prevent obstructions when driving. Cables or wiring that obstruct or hang up on places such as the steering wheel, gear lever, brake pedals, etc. can be extremely hazardous.

DO NOT SPLICE INTO ELECTRICAL CABLES.

Never cut away cable insulation to supply power to other equipment. Doing so will exceed the current carrying capacity of the wire and result in fire or electric shock.

DO NOT DAMAGE PIPE OR WIRING WHEN DRILLING HOLES.

When drilling holes in the chassis for installation, take precautions so as not to contact, damage or obstruct pipes, fuel lines, tanks or electrical wiring. Failure to take such precautions may result in fire.

DO NOT USE BOLTS OR NUTS IN THE BRAKE OR STEERING SYSTEMS TO MAKE GROUND CONNECTIONS.

Bolts or nuts used for the brake or steering systems (or any other safety-related system), or tanks should NEVER be used for installations or ground connections. Using such parts could disable control of the vehicle and cause fire etc.

KEEP SMALL OBJECTS SUCH AS BOLTS OR SCREWS OUT OF THE REACH OF CHILDREN.

Swallowing them may result in serious injury. If swallowed, consult a physician immediately.

DO NOT INSTALL IN LOCATIONS WHICH MIGHT HINDER VEHICLE OPERATION, SUCH AS THE STEERING WHEEL OR GEARSHIFT.

Doing so may obstruct forward vision or hamper movement etc. and results in serious accident.

Caution

HAVE THE WIRING AND INSTALLATION DONE BY EXPERTS.

The wiring and installation of this unit requires special technical skill and experience. To ensure safety, always contact the dealer where you purchased this product to have the work done.

USE SPECIFIED ACCESSORY PARTS AND INSTALL THEM SECURELY.

Be sure to use only the specified accessory parts. Use of other than designated parts may damage this unit internally or may not securely install the unit in place. This may cause parts to become loose resulting in hazards or product failure.

ARRANGE THE WIRING SO IT IS NOT CRIMPED OR PINCHED BY A SHARP METAL EDGE.

Route the cables and wiring away from moving parts (like the seat rails) or sharp or pointed edges. This will prevent crimping and damage to the wiring. If wiring passes through a hole in metal, use a rubber grommet to prevent the wires insulation from being cut by the metal edge of the hole.

DO NOT INSTALL IN LOCATIONS WITH HIGH MOISTURE OR DUST.

Avoid installing the unit in locations with high incidence of moisture or dust. Moisture or dust that penetrates into this unit may result in product failure.

Precautions

- Be sure to disconnect the cable from the (-) battery post before installing your IVA-D900. This will reduce any chance of damage to the unit in case of a short-circuit.
- Be sure to connect the color coded leads according to the diagram. Incorrect connections may cause the unit to malfunction or damage to the vehicle's electrical system.
- When making connections to the vehicle's electrical system, be aware of the factory installed components (e.g. on-board computer). Do not tap into these leads to provide power for this unit. When connecting the IVA-D900 to the fuse box, make sure the fuse for the intended circuit of the IVA-D900 has the appropriate amperage. Failure to do so may result in damage to the unit and/or the vehicle. When in doubt, consult your ALPINE dealer.
- The IVA-D900 uses female RCA-type jacks for connection to other units (e.g. amplifier) having RCA connectors. You may need an adaptor to connect other units. If so, please contact your authorized ALPINE dealer for assistance.
- Be sure to connect the speaker (-) leads to the speaker (-) terminal. Never connect left and right channel speaker cables to each other or to the vehicle body.
- The Display must be completely retracted in the casing when installing. If it is not, problems may occur.
- When installing in automobiles, make sure the Display can open/close without coming in contact with the gear shift .

IMPORTANT

Please record the serial number of your unit in the space provided below and keep it as a permanent record. The serial number plate is located on the bottom of the unit.

SERIAL NUMBER: _____
INSTALLATION DATE: _____
INSTALLATION TECHNICIAN: _____
PLACE OF PURCHASE: _____

Installation

Installing the Monitor

Installation Location

Before deciding on the mounting location, check that opening and closing the display will not hamper gear shifting in that position.

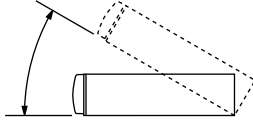

- Install at an angle of within 30 degrees from the horizontal.

1

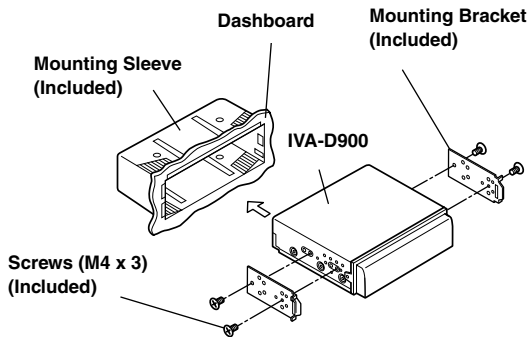

Slide the mounting sleeve into the dashboard. Install the supplied bracket on the monitor.

- Make sure to use the supplied screw (M4 x 3) to install the monitor.
If you use another screw to install the monitor, it may cause a malfunction.

2

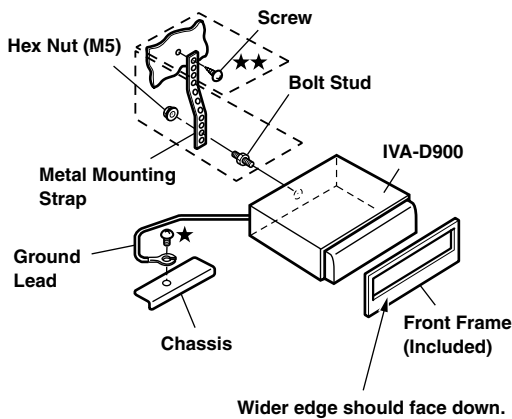

Reinforce the monitor unit with a metal mounting strap (not supplied). Secure the ground lead of the unit to a clean metal spot using a screw (★) already attached to the vehicle's chassis.

- For the screw marked ★★, use an appropriate screw for the chosen mounting location.

Connect each input lead coming from an amplifier or equalizer to the corresponding output lead coming from the left rear of the IVA-D900. Connect all other leads of the IVA-D900 according to details described in the Connections section.

3

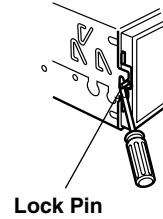

Slide the IVA-D900 into the dashboard. When the unit is in place, make sure the locking pins are fully seated in the down position. This can be done by pressing firmly in on the unit while pushing the locking pin down with a small screwdriver. This ensures that the unit is properly locked and will not accidentally come out from the dashboard. Install the supplied Front Frame.

Removal

1. Use a small screwdriver (or similar tool) to push the locking pins to the "up" position (see Step 3). As each pin is unlocked, gently pull out on the unit to make sure it does not re-lock before unlocking the second pin.
2. Pull the unit out, keeping it unlocked as you do so.

< JAPANESE CAR >

To install using the vehicle's standard bracket.

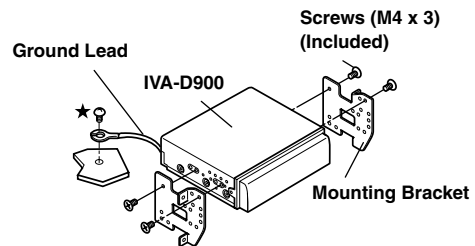

- Make sure to use the supplied screw (M4 x 3) to install the monitor.
If you use another screw to install the monitor, it may cause a malfunction.

Installing the Tuner Box

Caution

Do not block the unit's fan or heat sink, thus preventing air circulation. If blocked, heat will accumulate inside the unit and may cause a fire.

Air ventilation hole

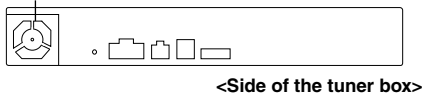

- 2 Install the tuner on the floor with the supplied flange-head tapping screws (M4 x 14).

Flange-head tapping screws (M4 x 14) (Included)

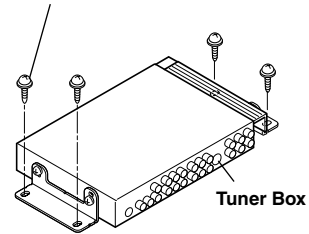

When mounting with Velcro fasteners

When mounting the tuner with the Velcro fasteners, be sure to choose a flat location.

Do not hang the unit from the bottom of the dashboard or rear deck with the Velcro fasteners.

- 1 Remove the Protective paper and attach two pieces of Velcro fastener to the bottom of the Tuner.

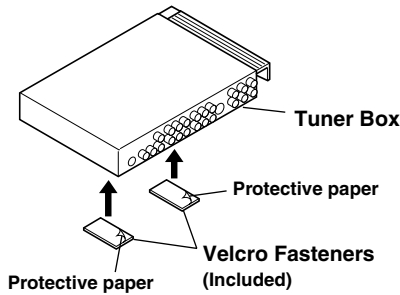

- 2 Check the position, and then fix the Tuner to the floor carpet.

When mounting with Screws

When mounting the tuner with the screws, be sure to choose a flat location.

When making holes, be careful not to scratch any pipes or wires.

- 1 Connect the bracket to both the flanks of the tuner with the supplied pan screws (M4 x 8).

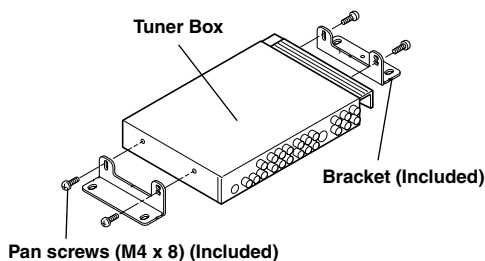

Installing the DC/DC Converter

Install the DC/DC Converter on the floor with the supplied flange-head tapping screws (M4 x 14).

Flange-head tapping screws (M4 x 14) (Included)

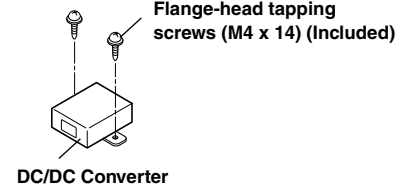

Mounting the remote control holder

- If the remote control is in direct sunlight, remove it from the holder and keep it in the glove box.
- When the holder cannot be mounted securely with Velcro tape, mount it by using screws.

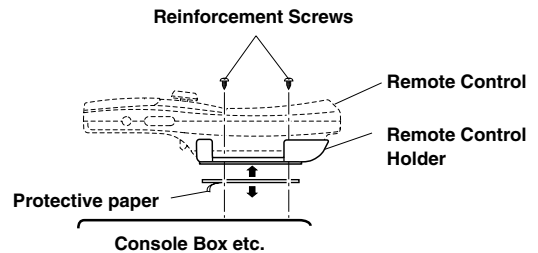

Parking Brake Lead Connection

If necessary, use a pinch connector to connect the foot brake lead, parking brake lead, etc.

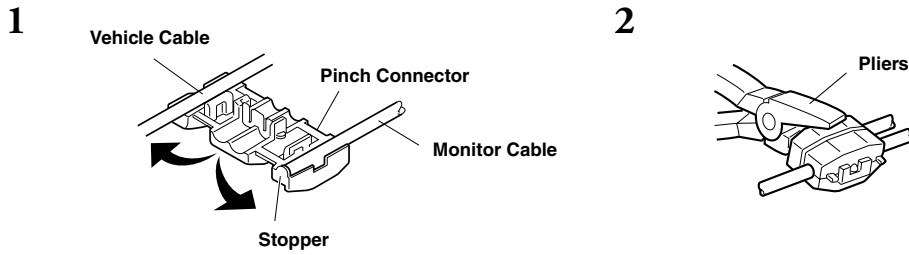

Foot Brake Lead / Parking Brake Lead Connection

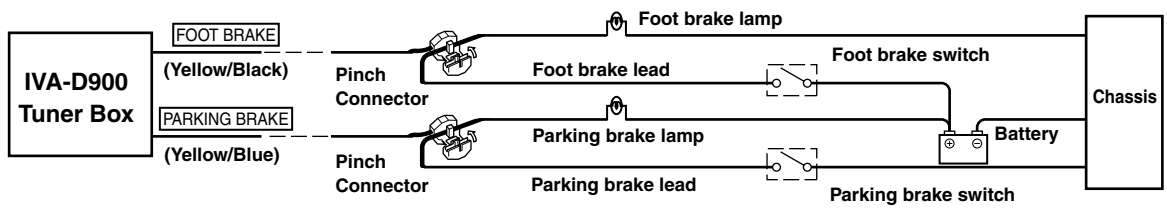

Connection Diagram of SPST Switch (Sold Separately)

(If the ACC power supply is not available)

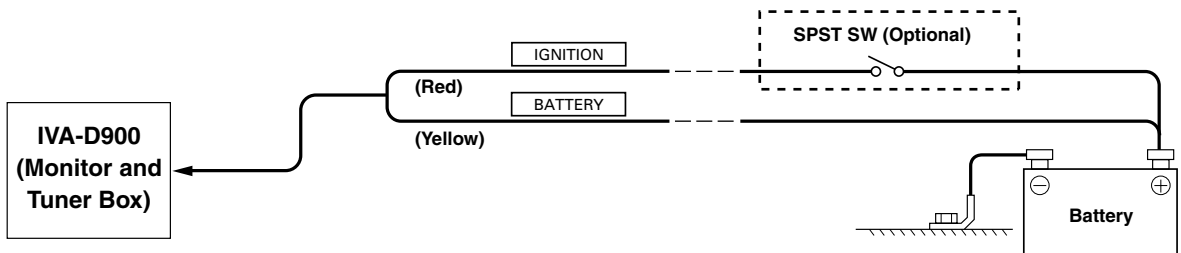

- If your vehicle has no ACC power supply, add an SPST (Single-Pole, Single-Throw) switch (sold separately).
- If the switched power (ignition) lead of the IVA-D900 is connected directly to the positive (+) post of the vehicle's battery, the IVA-D900 draws some current (several hundred milliamperes) even when its switch is placed in the OFF position and the battery may be discharged.

Connections (IVA-D900 Wiring Diagram)

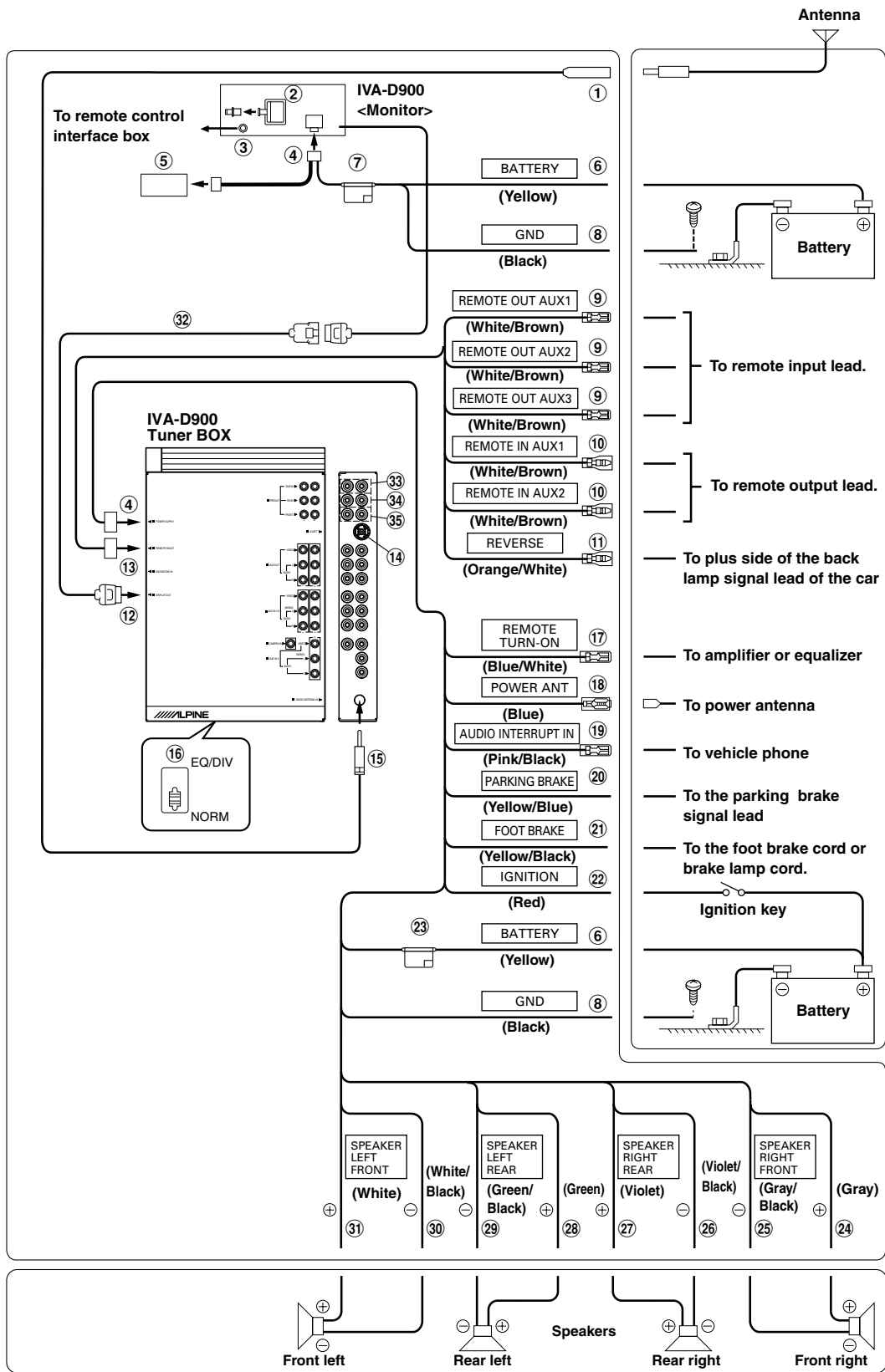

• Set the system switch to "NORM" when only a changer is connected (when the Ai-NET compatible equalizer is not used).

- ① **Antenna Extension Cable**
- ② **Digital Output Terminal (Optical)**
Use when combining fiber digital input compatible products.
- ③ **Remote Control Interface Connector**
Connect to the remote control interface box.
- ④ **Power Supply Connector**
- ⑤ **DC/DC Converter**
 - Do not install the converter at a location subjected to water such as under the floor mat or air conditioner. This may cause a malfunction.
 - Do not bundle the DC/DC converter cable with other audio cables. Doing so may induce noise into your system.
 - Keep the DC/DC converter away from the Antenna cables and the rear side of the unit, otherwise noise may be generated when receiving radio broadcast.
- ⑥ **Battery Lead (Yellow)**
Connect this lead to the positive (+) post of the vehicle's battery.
- ⑦ **Fuse Holder (10A)**
- ⑧ **Ground Lead (Black)**
Connect this lead to a good chassis ground on the vehicle. Make sure the connection is made to bare metal and is securely fastened using the sheet metal screw provided.
- ⑨ **Remote Control Output Lead (White/Brown)**
Connect this lead to the remote control input lead. This lead outputs the controlling signals from the remote control.
- ⑩ **Remote Control Input Lead (White/Brown)**
Connect the external Alpine product to the remote control output lead.
- ⑪ **Reverse Lead (Orange/White)**
Use only when a back-up camera is connected. Connect to the plus side of the car's reverse lamp that lights when the transmission is shifted into reverse (R). Switches the video picture to the back-up camera. This is linked with putting the car into reverse (R).
- ⑫ **Display Output Terminal**
- ⑬ **Remote IN/OUT Terminal**
- ⑭ **Ai-NET Connector**
Connect this to the output or input connector of other product (CD Changer, Equalizer, etc.) equipped with Ai-NET.
- ⑮ **Antenna Receptacle**
- ⑯ **System Switch**
When connecting an equalizer or divider using Ai-NET feature, place this switch in the EQ/DIV position. When no device is connected, leave the switch in the NORM position.
 - Be sure turn the power off to the unit before changing the switch position.
- ⑰ **Remote Turn-On Lead (Blue/White)**
Connect this lead to the remote turn-on lead of your amplifier or signal processor.
- ⑱ **Power Antenna Lead (Blue)**
Connect this lead to the +B terminal of your power antenna, if applicable.
- ⑲ **Audio Interrupt In Lead (Pink/Black)**
- ⑳ **Parking Brake Lead (Yellow/Blue)**
Connect this lead to the power supply side of the parking brake switch to transmit the parking brake status signals to the IVA-D900.
- ㉑ **Foot Brake Lead (Yellow/Black)**
Connect to the vehicle's foot brake lead or brake lamp lead.
- ㉒ **Switched Power Lead (Ignition) (Red)**
Connect this lead to an open terminal on the vehicle's fuse box or another unused power source which provides (+) 12V only when the ignition is turned on or in the accessory position.
- ㉓ **Fuse Holder (15A)**
- ㉔ **Right Front (+) Speaker Output Lead (Gray)**
- ㉕ **Right Front (-) Speaker Output Lead (Gray/Black)**
- ㉖ **Right Rear (-) Speaker Output Lead (Violet/Black)**
- ㉗ **Right Rear (+) Speaker Output Lead (Violet)**
- ㉘ **Left Rear (+) Speaker Output Lead (Green)**
- ㉙ **Left Rear (-) Speaker Output Lead (Green/Black)**
- ㉚ **Left Front (-) Speaker Output Lead (White/Black)**
- ㉛ **Left Front (+) Speaker Output Lead (White)**
- ㉜ **Monitor Extension Cable (Included)**
- ㉝ **Subwoofer output Terminal**
Connect the input lead of an amplifier for the subwoofer to this terminal.
- ㉞ **Rear output Terminal**
Use when connecting an amplifier.
- ㉟ **Front output Terminal**
Use when connecting an amplifier.

To prevent external noise from entering the audio system.

- Locate the unit and route the leads at least 10 cm away from the car's electrical harness.
- Keep the battery power leads as far away from other leads as possible.
- Connect the ground lead securely to a bare metal spot (remove any paint, dirt or grease if necessary) of the car chassis.
- If you add an optional noise suppressor, connect it as far away from the unit as possible. Your Alpine dealer carries various noise suppressors, contact them for further information.
- Your Alpine dealer knows best about noise prevention measures so consult your dealer for further information.

System Example

When connecting the Ai-NET compatible audio processor (Fiber digital compatible), Navigation system, DVD player and changer

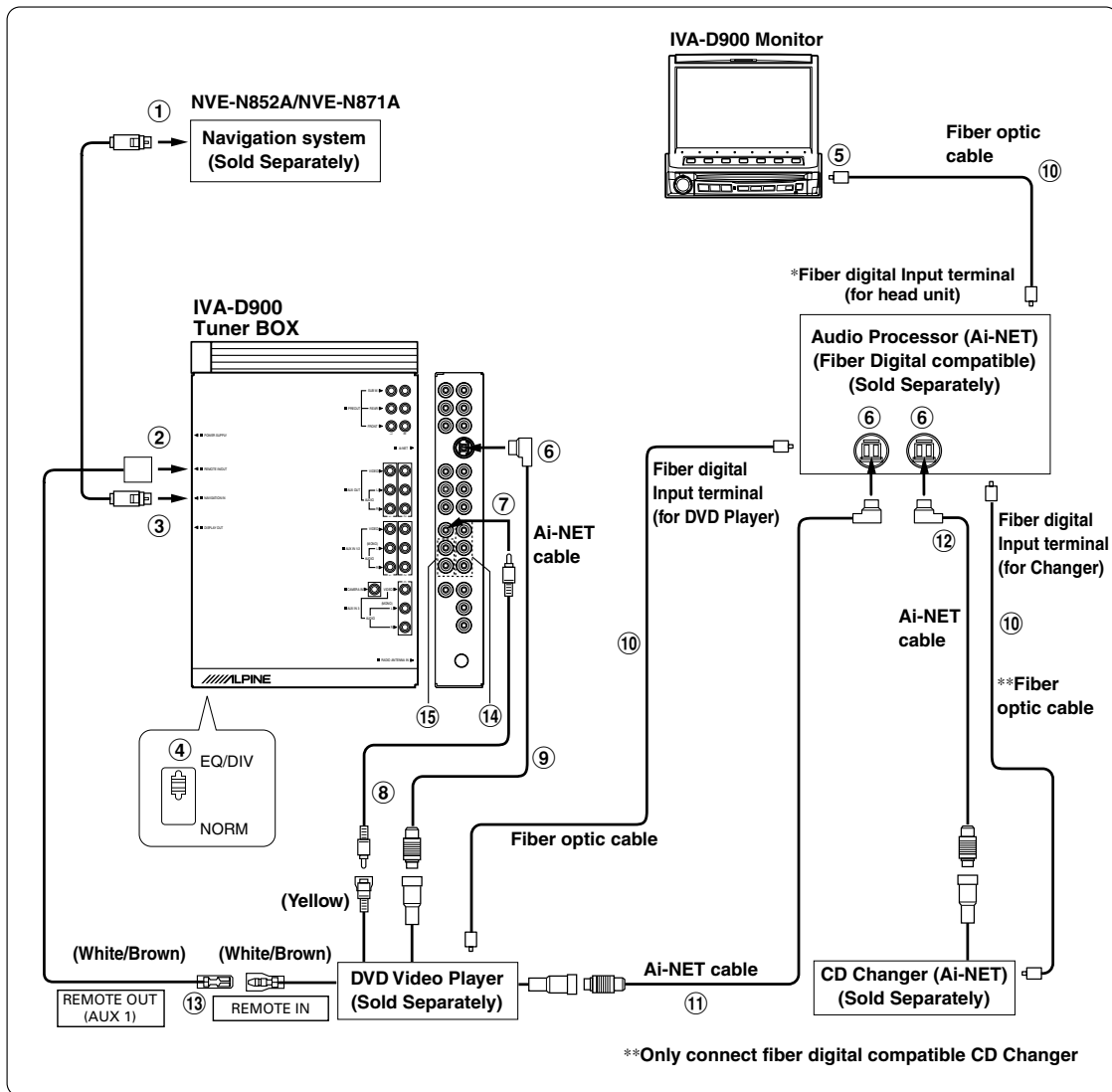

- When the fiber digital compatible product is connected, it is necessary to set the mode of this unit. Refer to "Setting the Digital Output" (page 31) and set to ON. Then refer to "Optical Digital Input Selection for an External Audio Processor" (page 34) and switch the setting.
- * When connecting with PXA-H510 :
 - Connect the fiber digital input terminal to the DVD.
 - IVA-D900, DVA-5200 or DVA-5205 cannot be connected simultaneously when fiber digital is in use.
- When the NVA-N751AS is connected for the Navigation System, use the RGB conversion cable KWE-503N (Sold separately).

Continued

- ① **RGB Cable (Included with NVE-N852, not included with NVE-N871A)**
- ② **Remote IN/OUT Terminal**
- ③ **RGB Input Terminal**

Connect this to the RGB output terminal of the Navigation System.
- ④ **System Switch**

When connecting an equalizer or divider using Ai-NET feature, place this switch in the EQ/DIV position. When no device is connected, leave the switch in the NORM position.

 - *Be sure to turn the power off to the unit before changing the switch position.*
- ⑤ **Digital Output Terminal**
- ⑥ **Ai-NET Connector**

Connect this to the output or input connector of other product equipped with Ai-NET.
- ⑦ **AUX Video Input (AUX1) Terminal**

Connect the video output lead of a DVD video player or DVD changer to this terminal.
- ⑧ **RCA Extension Cable (Included with DVD video player)**
- ⑨ **Ai-NET Cable (Included with DVD video player)**
- ⑩ **Fiber optic Cable (Sold Separately)**
- ⑪ **Ai-NET Cable (Included with Equalizer)**
- ⑫ **Ai-NET Cable (Included with CD Changer)**
- ⑬ **Remote Control Output Lead (White/Brown)**

Connect this lead to the remote control input lead. This lead outputs the controlling signals from the remote control.
- ⑭ **AUX Audio/Video Input (AUX2) Terminals**
- ⑮ **AUX Audio Input (AUX1) Terminals**

When Connecting External Equipment

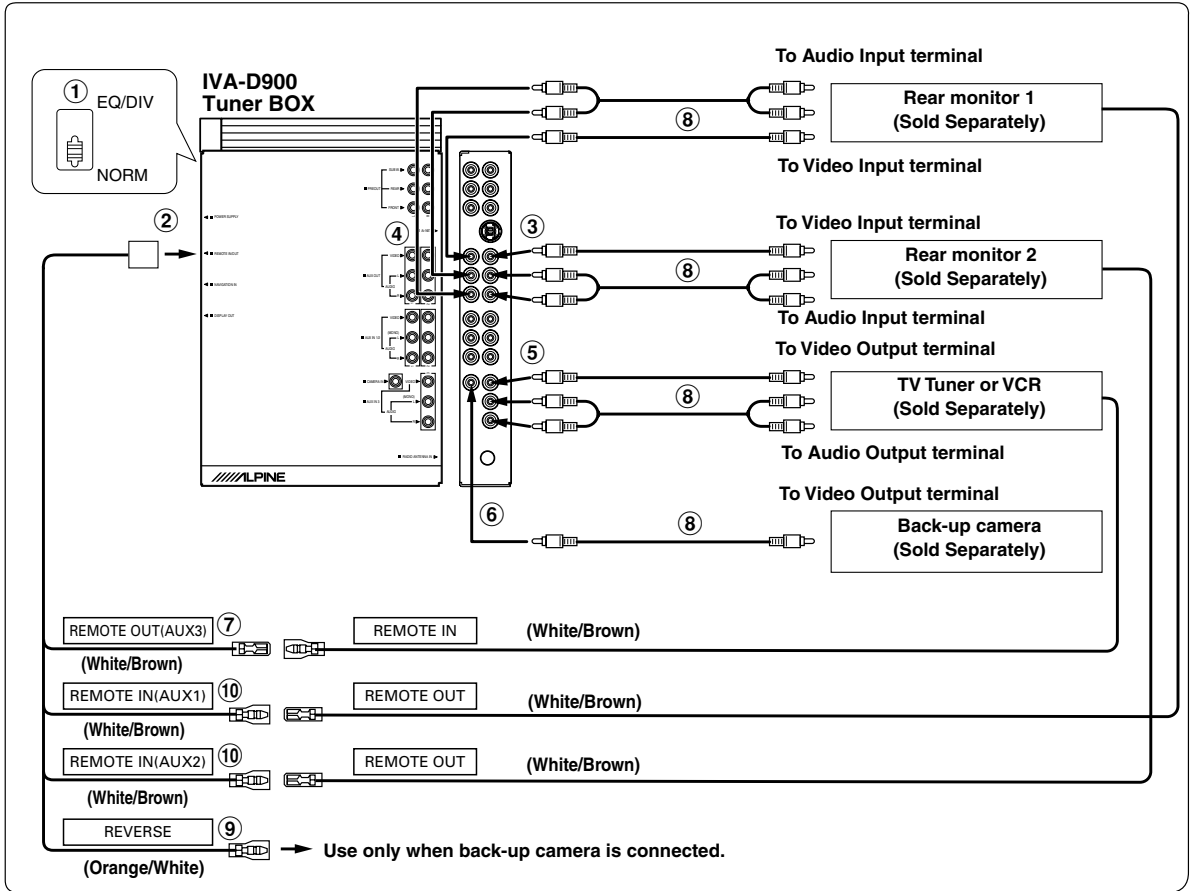

① System Switch

When connecting an equalizer or divider using Ai-NET feature, place this switch in the EQ/DIV position. When no device is connected, leave the switch in the NORM position.

- Be sure to turn the power off to the unit before changing the switch position.

② Remote IN/OUT Terminal

③ AUX Video/Audio Output (AUX2) Terminal

Use when connecting an optional monitor etc.

④ AUX Video/Audio Output (AUX1) Terminal

Use when connecting an optional monitor etc.

⑤ AUX Video/Audio Input (AUX3) Terminal

⑥ CAMERA Input Terminal

Use when connecting a back-up camera.

⑦ Remote Control Output Lead (White/Brown)

Connect this lead to the remote control input lead. This lead outputs the controlling signals from the remote control.

⑧ RCA Extension Cable (Sold separately)

- ### ⑨ Connect to the plus side of the car's reverse lamp which lights when the transmission is shifted into reverse (R). Switches the video picture to the back-up camera. This is linked to putting the car into reverse (R).

⑩ Remote Control Input Lead (White/Brown)

LIMITED WARRANTY

ALPINE ELECTRONICS OF AMERICA, INC. AND ALPINE OF CANADA INC. ("Alpine"), are dedicated to quality craftsmanship and are pleased to offer this Warranty. We suggest that you read it thoroughly. Should you have any questions, please contact your Dealer or Alpine at one of the telephone numbers listed below.

● PRODUCTS COVERED:

This Warranty covers Car Audio/Visual Products and Related Accessories ("the product"). Products purchased in the Canada are covered only in the Canada. Products purchased in the U.S.A. are covered only in the U.S.A.

● LENGTH OF WARRANTY:

This Warranty is in effect for one year from the date of the first consumer purchase.

● LIFETIME TAPE HEAD WARRANTY:

All Alpine Car Audio analog tape heads excluding Video tape heads are warranted for life against manufacturing defects causing failure.

● WHO IS COVERED:

This Warranty only covers the original purchaser of the product, who must reside in the United States, Puerto Rico or Canada.

● WHAT IS COVERED:

This Warranty covers defects in materials or workmanship (parts and labor) in the product.

● WHAT IS NOT COVERED:

This Warranty does not cover the following:

- ① Damage occurring during shipment of the product to Alpine for repair (claims must be presented to the carrier).
- ② Damage caused by accident, abuse, negligence, misuse, improper connections, improper operation or failure to follow instructions contained in the Owner's manual.
- ③ Damage caused by act of God, including without limitation, earthquake, fire, flood, storms or other acts of nature.
- ④ Any cost or expense related to the removal or reinstallation of the product.
- ⑤ Service performed by an unauthorized person, company or association.
- ⑥ Any product which has the serial number defaced, altered or removed.
- ⑦ Any product which has been adjusted, altered or modified without Alpine's consent.
- ⑧ Any product not distributed by Alpine within the United States, Puerto Rico or Canada.
- ⑨ Any product not purchased from an Authorized Alpine Dealer.
- ⑩ Any product that has been determined to contain an excessive amount of dust or dirt and any product that contains other contaminants including liquid or foreign objects.

● HOW TO OBTAIN WARRANTY SERVICE:

- ① You are responsible for delivery of the product to an Authorized Alpine Service Center or Alpine for repair and for payment of any initial shipping charges. Alpine will, at its option, repair or replace the product with a new or reconditioned product without charge. If the repairs are covered by the warranty, and if the product was shipped to an Authorized Alpine Service Center or Alpine, Alpine will pay the return shipping charges.
- ② You should provide a detailed description of the problem(s) for which service is required.
- ③ You must supply proof of your purchase of the product.
- ④ You must package the product securely to avoid damage during shipment.

● HOW WE LIMIT IMPLIED WARRANTIES:

ANY IMPLIED WARRANTIES INCLUDING FITNESS FOR USE AND MERCHANTABILITY ARE LIMITED IN DURATION TO THE PERIOD OF THE EXPRESS WARRANTY SET FORTH ABOVE AND NO PERSON IS AUTHORIZED TO ASSUME FOR ALPINE ANY OTHER LIABILITY IN CONNECTION WITH THE SALE OF THE PRODUCT.

● HOW WE EXCLUDE CERTAIN DAMAGES:

ALPINE EXPRESSLY DISCLAIMS LIABILITY FOR INCIDENTAL AND CONSEQUENTIAL DAMAGES CAUSED BY THE PRODUCT. THE TERM "INCIDENTAL DAMAGES" REFERS TO EXPENSES OF TRANSPORTING THE PRODUCT TO THE ALPINE SERVICE CENTER, LOSS OF THE ORIGINAL PURCHASER'S TIME, LOSS OF THE USE OF THE PRODUCT, BUS FARES, CAR RENTALS OR OTHERS COSTS RELATING TO THE CARE AND CUSTODY OF THE PRODUCT. THE TERM "CONSEQUENTIAL DAMAGES" REFERS TO THE COST OF REPAIRING OR REPLACING OTHER PROPERTY WHICH IS DAMAGED WHEN THIS PRODUCT DOES NOT WORK PROPERLY. THE REMEDIES PROVIDED UNDER THIS WARRANTY ARE EXCLUSIVE AND IN LIEU OF ALL OTHERS.

● HOW STATE/PROVINCIAL LAW RELATES TO THE WARRANTY:

This Warranty gives you specific legal rights, and you may also have other rights which vary from state to state and province to province. In addition, some states/provinces do not allow limitations on how long an implied warranty lasts, and some do not allow the exclusion or limitation of incidental or consequential damages. Accordingly, limitations as to these matters contained herein may not apply to you.

● IN CANADA ONLY:

This Warranty is not valid unless your Alpine car audio product has been installed in your vehicle by an Authorized Installation Center, and this warranty stamped upon installation by the installation center.

● HOW TO CONTACT CUSTOMER SERVICE:

Should the product require service, please call the following number for your nearest Authorized Alpine Service Center.

| |
|--|
| U.S.A. 1-800-ALPINE-1 (1-800-257-4631) CANADA 1-800-ALPINE-1 (1-800-257-4631) |
|--|

Alpine Electronics of America, Inc., 19145 Gramercy Place, Torrance, California 90501, U.S.A.

Alpine Electronics of Canada, Inc., Suite 203, 7300 Warden Ave. Markham, Ontario, L3R 9Z6, Canada

